

PAVERS
WALL STONES

FENDT 1924
96
YEARS
MADE IN MICHIGAN

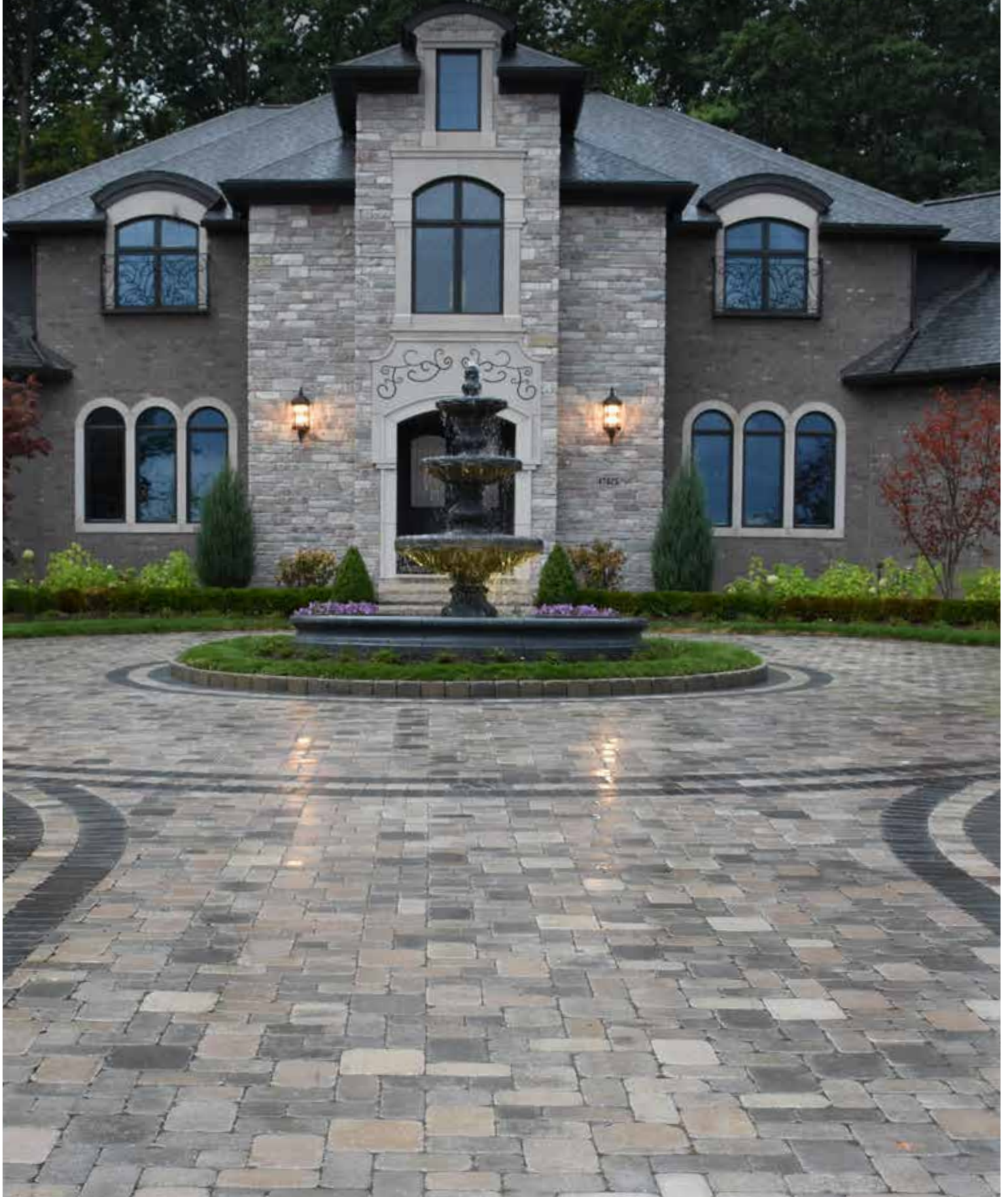



› OUR HISTORY

Nothing brings more beauty to your outdoor living than a landscape beautifully adorned with paving brick and stone work. Now celebrating our 96th year in business, we have been providing the products and service that can turn any landscape into an earth-friendly and welcoming environment and can often increase the value of your home. Ever since my grandfather, Leo Fendt, began mining sand and gravel on our present site on Gill Road in Farmington, Michigan, in 1924, we've been creating building blocks for Michigan homes and businesses. But we have not just been passionate about the structural benefits of solid and durable masonry products and construction for thousands of homes, offices, factories and schools across the state. In the early '80s, my father's passion guided us in finding new ways to turn common grounds into beautiful and purposeful outdoor living spaces. Our paving stones and retaining wall blocks have transformed the ordinary backyard into the extraordinary family oasis – a true extension of the home.

› OUR PHILOSOPHY

Michigan was built on good old-fashioned, hard-working, Middle-American, family values. We like to think we're representative of those values. We work hard, like you do, to provide the best for our families. We shop locally, worship locally and we send our kids to the local schools. Because we believe that in order to be good at our business, we also have to be good neighbors. Embedded in the community. Always ready to lend a hand. We're good listeners too. Charitable. Honest. Trustworthy. In fact, it's truly been my pleasure, over the years, to be able to personally meet and discuss building and landscaping plans with customers like you at our local stores. It's nice to know so many still appreciate quality products and service for a fair price. Funny, that's been the cornerstone of our business since its inception. My grandfather, my father and I have all believed in the power of listening to our customers and letting their input help shape how we innovate and how we conduct business.

› SALUTE TO SERVICE



Without the dedication of the brave men and women who serve through our U.S. armed forces, our state and local police and fire departments, or as first responders, we wouldn't be able to enjoy the freedoms we're granted as American citizens. That's why we're honored to have provided the paving stones and wall stones adorning the Michigan State police post in Brighton, Michigan. To all who serve...thank you for your service!

› SPECIAL THANKS TO YOU...OUR CUSTOMERS

As we approach our company's centennial in business, our families would like to thank yours for the continued support and patronage throughout the years. We're so humbled to have been able to provide service for so many great customers and we look forward to working with families like yours in the near future.

Sincerely,

Alan Fendt
 Alan Fendt
 President



CONTENTS

IDEA GALLERY 4-12

PAVERS

Old World Holland 4x8 14-15
 Old World Vintage 16-19
 Old World Vintage Patterns 20-21
 Harbor Stone 22-26
 Harbor Stone & Bay Stone Patterns 27
 New Bay Stone 28-29
 Vintage Series 30-33
 Vintage Series Patterns 34-35
 Symetry 36-38
 Symetry Patterns 39
 Holland 4x8 40-43
 Holland Series 44-49
 Standard Color Chart 50
 Spectrum & Elite Color Chart 51
 Old World Color Chart 52
 Accent Pavers Color Chart 53
 Custom Color Projects 54-55
 Installation Instructions 56

ENVIRONMENTAL

Permeable Pavers 58-61
 Monoslab® Grass Paver 62-63
 Geolink Erosion Control 64

WALL STONES

Garden Wall 66
 Glenstone 67
 Old World Glenstone 68
 Old World Glenstone Bullnose 69
 Verazzo Stone 70-73
 Murino 74-75
 Stonegate 76-79
 Old World Stonegate 80-81
 Caps & Steps 82
 Piers 83
 Design Details 84-85
 Wall Caps & Stair Treads 86-87
 Coping Stone 88
 Old World Glenstone Bullnose 89
 Fire Pit Block 90-91
 Keystone Compac Hewnstone 92-95
 Keystone Straight Split 96-97
 Keystone Sculptured Split 98-99
 Design Details & Charts 100-103
 Installation Instructions 104
 Landscape Wall Colors 105
 Reference Guide 106-107



Fendt is a proud member of both the Interlocking Concrete Pavement Institute (ICPI) and the National Concrete Masonry Association (NCMA). These organizations are recognized as the leading national associations for the advancement of properly designed and installed concrete paving stones and segmental retaining walls, respectively. We recommend that installations of our quality products follow the accepted installation standards of the ICPI and NCMA.



➤ WARRANTY

Fendt Builder's Supply, Inc., guarantees the structural integrity of our paver and retaining wall products to the original purchaser for residential applications. Should any product prove defective by not meeting existing ASTM specifications and standards, it will be replaced without cost. Replacement labor and shipping costs are not included in this guarantee. Color matching of any replacement units cannot be guaranteed. Proof of original purchase is required.

GUIDELINES FOR NON-WARRANTIED TOPICS

COLORS

The colors of products shown in this catalog are to be used as representations or guidelines only. The photography and printing processes are not fully capable of reproducing exact color of all products. Colors may also change from production run to production run. Not all colors are available in all shapes – check with the sales department for availability. Fendt Builder's Supply, Inc., may change, amend, add or discontinue any product, shape, style or color at its sole discretion with no prior notification. To assure random color distribution, it is recommended that individual blocks and/or pavers be mixed from different pallets on the job site.

CLEANING AND MAINTENANCE

Efflorescence, a white deposit common on concrete and masonry surfaces, is a natural occurrence and no warranty or liability is either expressed or implied for this condition. Cleaners are available for the removal of efflorescence. Residues left on pavers and wall stones from saw-cutting of units or from improper installation of polymeric sands are not the responsibility of Fendt. Cleaners are available for these situations. The face of retaining walls can be stained due to mineral and soil-laden moisture in the backfill area. Cleaners and sealers are available for routine maintenance.

SNOW REMOVAL AND SALTING

Snow can be shoveled or plowed from pavers as readily as other pavements. High-strength, low-absorption Fendt pavers are more resistant to de-icing salts than ordinary concretes, but they can still be damaged by intense application. Magnesium chloride is less damaging to concrete surfaces than other rock salt (sodium chloride) or calcium chloride.

IDEA GALLERY – WALKWAYS

PAVERS: OLD WORLD VINTAGE – POLAR ASH
ACCENT PAVERS: OLD WORLD VINTAGE XLR – JET BLACK
STEP COPING: OLD WORLD GLENSTONE BULLNOSE – LIMESTONE BLEND



IDEA GALLERY – DRIVEWAYS

› PAVERS: SYMETRY™ – RUSTIC BLEND
6x6 – CUSTOM CREAM

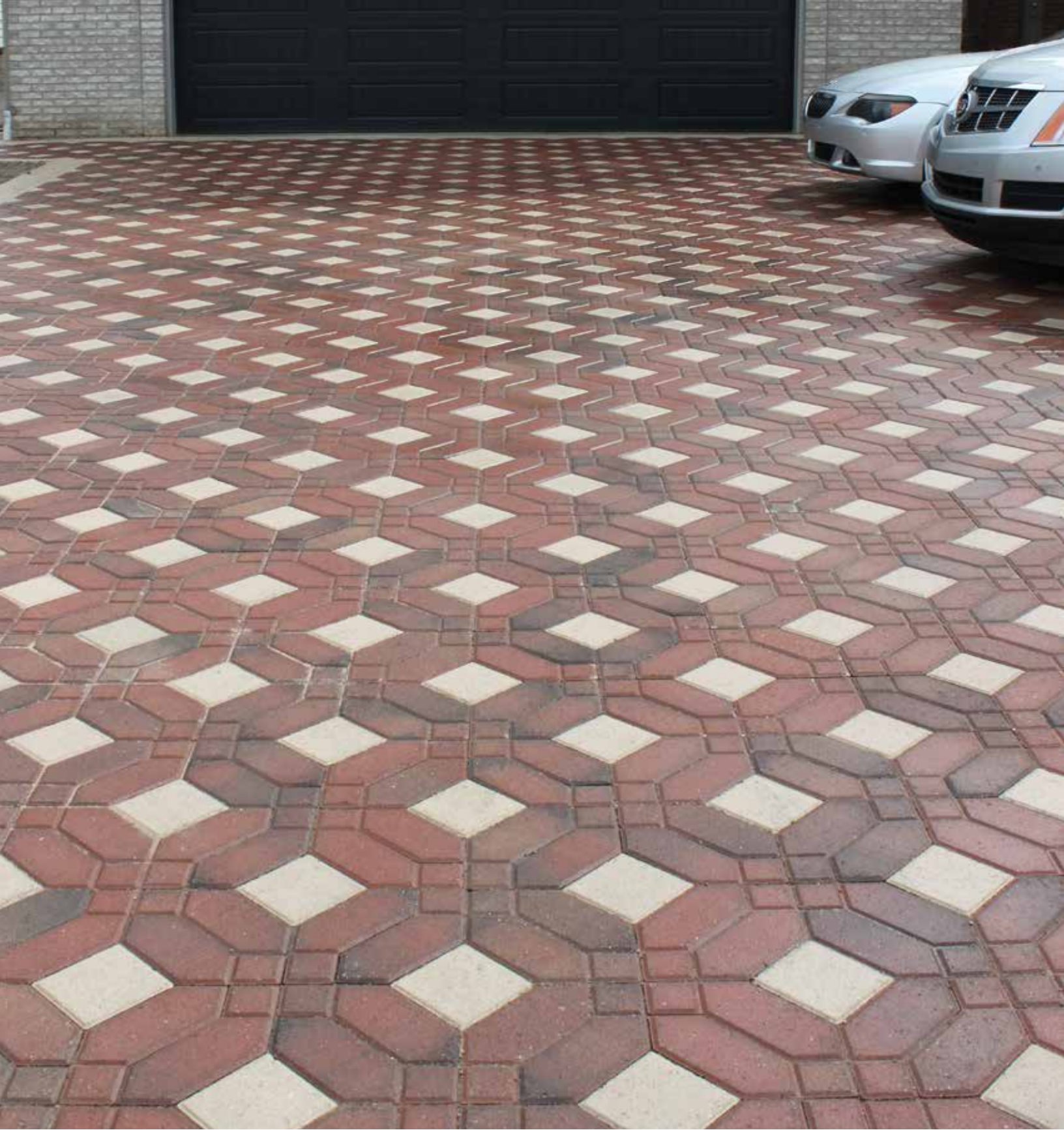

IDEA GALLERY – PATIOS

PAVERS: 4x8 HOLLAND – POLAR ASH
WALLS: STONEGATE – SLATE
CAPS: 3x24 CAP – LIMESTONE BLEND



IDEA GALLERY – POOLS

PAVERS: OLD WORLD VINTAGE – POLAR ASH
ACCENT PAVERS: OLD WORLD VINTAGE XLR – JET BLACK
WALL STONES: OLD WORLD STONEGATE – LIMESTONE BLEND
ACCENT WALL STONES: OLD WORLD STONEGATE – SLATE
CAPS: 3x24 SMOOTH CAP – LIMESTONE BLEND
POOL COPING: COPING STONE – SLATE



IDEA GALLERY – OUTDOOR KITCHENS

› PAVERS: OLD WORLD VINTAGE – LIMESTONE BLEND
ACCENT PAVERS: OLD WORLD VINTAGE XLR – JET BLACK
WALL STONES: OLD WORLD STONEGATE – LIMESTONE BLEND
ACCENT WALL BAND: OLD WORLD STONEGATE – SLATE



IDEA GALLERY – FIRE PIT

› WALL & FIRE PIT: VERAZZO STONE – CAMEL
WALL & FIRE PIT CAPS: GLENSTONE & GLENSTONE BULLNOSE – CAMEL
STEPS: GLENSTONE BULLNOSE – CAMEL
PAVERS: HOLLAND SERIES – WALNUT BLEND
ACCENT PAVERS: HOLLAND 4x8 – SLATE
PIER ACCENT COURSE: GLENSTONE – SLATE



IDEA GALLERY – PRIVACY WALLS

WALLS: OLD WORLD STONEGATE – LIMESTONE BLEND
ACCENT WALL COURSE: OLD WORLD STONEGATE – SLATE
CAP: 3x24 SMOOTH CAP – LIMESTONE BLEND



IDEA GALLERY – RETAINING WALLS

▶ PAVERS: HOLLAND SERIES – WALNUT BLEND
STEP PAVERS: 4x8 HOLLAND – WALNUT BLEND
WALLS: COMPAC HEWNSTONE – CAMEL
CAPS: 3x24 CAP – WALNUT BLEND

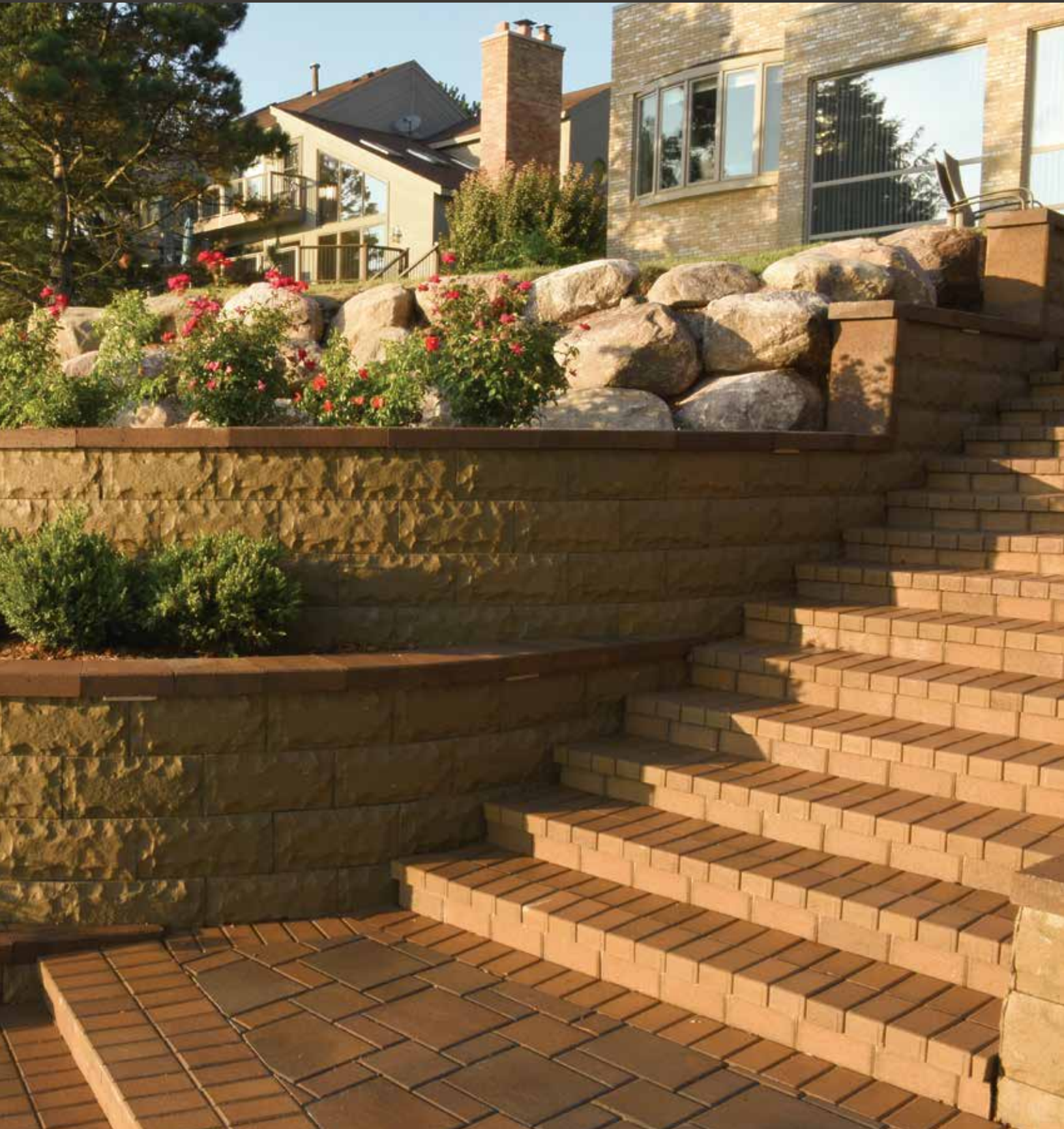

IDEA GALLERY – OUTDOOR FIREPLACES

PAVERS: HARBOR STONE – WALNUT BLEND
WALLS & OVEN: STONEGATE – WALNUT BLEND
CAPS: 3x24 CAP – SLATE



PAVING STONES

PAVERS: OLD WORLD VINTAGE – POLAR ASH
ACCENT PAVERS: OLD WORLD VINTAGE XLR – JET BLACK
STEP COPING: OLD WORLD GLENSTONE BULLNOSE – LIMESTONE BLEND

CONTENTS

Old World Holland 4x8	14-15
Old World Vintage	16-19
Old World Vintage Patterns	20-21
Harbor Stone	22-26
Harbor Stone & Bay Stone Patterns	27
New Bay Stone	28-29
Vintage Series	30-33
Vintage Series Patterns	34-35
Symetry	36-38
Symetry Patterns	39
Holland 4x8	40-43
Holland Series	44-49
Standard Color Chart	50
Spectrum & Elite Color Chart	51
Old World Color Chart	52
Accent Pavers Color Chart	53
Custom Color Projects	54-55
Installation Instructions	56



When it comes to choosing a pavement surface that combines beauty, strength, color, texture and durability, it's hard to look any further than interlocking concrete paving stones, or pavers, for the perfect answer for your driveway, walk or patio.

The wide range of styles and shapes gives the design flexibility to create the most imaginative layouts and patterns. The vast choices of vibrant colors open the possibilities to match virtually any color scheme that you can dream of. And the strength and durability of pavers will pass the most stringent engineering tests that concrete can be put through.

For many years, Fendt has been known as a premier and quality paver manufacturer with some of the richest and most varied colors available to the homeowner and designer alike. As you page through this catalog and begin to dream of your new or refurbished patio, pool deck or driveway, let your imagination dream what can be possible. Fendt — Dream in Color.

OLD WORLD HOLLAND 4x8

› NEXT PAGE:
PAVERS: OLD WORLD HOLLAND 4x8 – BURGUNDY BLEND
BORDERS: HOLLAND 4x8 – SLATE
OLD WORLD VINTAGE – LIMESTONE BLEND



OLD WORLD HOLLAND 4x8

Units per sq. ft.: 4.5
Sq. ft. per cube: 108
Weight per sq. ft.: 28 lbs.
Weight per cube: 3,024 lbs.

Sq. ft. per strap: 18
Soldier Coursing:
Per Strap – 27 lineal feet
Per Cube – 162 lineal feet

› RIGHT:
PAVERS: OLD WORLD HOLLAND 4x8 – RUSTIC BLEND
BORDER: HOLLAND 4x8 – SLATE

› BELOW:
PAVERS: OLD WORLD HOLLAND 4x8 – BURGUNDY BLEND
BORDERS: HOLLAND 4x8 – SLATE
OLD WORLD VINTAGE – LIMESTONE BLEND





O.W. RUSTIC BLEND



O.W. ANTIQUE BLEND



O.W. WALNUT BLEND



O.W. LIMESTONE BLEND



O.W. MOSSY OAK BLEND



O.W. SLATE

OLD WORLD VINTAGE

PAVERS: OLD WORLD VINTAGE – SEASHELL BLEND
ACCENT PAVERS: OLD WORLD VINTAGE XLR – COFFEE



PAVERS: OLD WORLD VINTAGE – POLAR ASH
ACCENT PAVERS: OLD WORLD VINTAGE XLR – JET BLACK



STANDARD COLORS



O.W. WALNUT BLEND



O.W. LIMESTONE BLEND

ELITE COLORS



O.W. SEASHELL BLEND



O.W. POLAR ASH



O.W. SUMMER WHEAT

OLD WORLD VINTAGE

PAVERS: OLD WORLD VINTAGE – POLAR ASH
STEPS & BORDERS: OLD WORLD GLENSTONE – SLATE

Large Square



Double Large Rectangle



XL Rectangle



Large Rectangle



Square



OLD WORLD VINTAGE SERIES

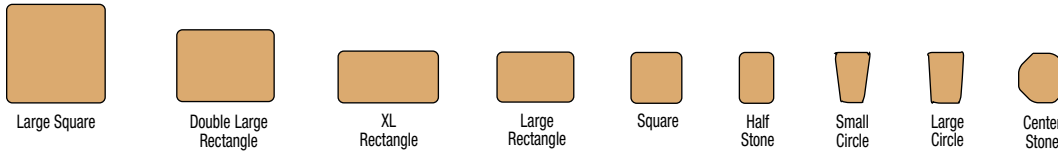

LARGE SQUARE CUBE		UNITS PER SQ. FT.	UNITS PER LAYER	SQ. FT. PER LAYER	UNITS PER CUBE	SQ. FT. PER CUBE	SQ. FT. PER STRAP	WEIGHT PER SQ. FT. (LBS.)		
	Large Square 9-1/2" x 9-1/2" x 2-3/8"	1.65	20	12.1	160	97	19.4	28		
DOUBLE LARGE RECTANGLE CUBE		UNITS PER SQ. FT.	UNITS PER LAYER	SQ. FT. PER LAYER	UNITS PER CUBE	SQ. FT. PER CUBE	SQ. FT. PER STRAP	WEIGHT PER SQ. FT. (LBS.)		
	Double Large Rectangle 7-1/8" x 9-1/2" x 2-3/8"	2.2	25	11.36	200	91	18.2	28		
XL RECTANGLE CUBE		UNITS PER SQ. FT.	UNITS PER LAYER	SQ. FT. PER LAYER	UNITS PER CUBE	SQ. FT. PER CUBE	SQ. FT. PER STRAP	WEIGHT PER SQ. FT.	SOLDIER COURSING LINEAL FOOTAGE	
	Extra Large Rectangle 9-1/2" x 4-3/4" x 2-3/8"	3.1	35	11.2	280	90	17.92	28	CUBE	STRAP
									111	22.2
LARGE RECTANGLE CUBE		UNITS PER SQ. FT.	UNITS PER LAYER	SQ. FT. PER LAYER	UNITS PER CUBE	SQ. FT. PER CUBE	SQ. FT. PER STRAP	WEIGHT PER SQ. FT.	SOLDIER COURSING LINEAL FOOTAGE	
	Large Rectangle 7-1/8" x 4-3/4" x 2-3/8"	4.2	42	10.0	336	80	13.33	28	CUBE	STRAP
									133	22.2
SQUARE CUBE		UNITS PER SQ. FT.	UNITS PER LAYER	SQ. FT. PER LAYER	UNITS PER CUBE	SQ. FT. PER CUBE	SQ. FT. PER STRAP	WEIGHT PER SQ. FT. (LBS.)		
	Square 4-3/4" x 4-3/4" x 2-3/8"	6.3	63	10.0	504	80	8.89	28		
CIRCLE BOX (1 CIRCLE PER BOX)		UNITS PER SQ. FT.	UNITS PER LAYER	SQ. FT. PER LAYER	UNITS PER BOX	SQ. FT. PER BOX	SQ. FT. PER STRAP	WEIGHT PER SQ. FT. (LBS.)		
	Square 4-3/4" x 4-3/4" x 2-3/8"	6.3			56	8.85		28		
	Large Circle 4-11/16" x 4-5/16" x 2-3/8"	8.3			120	14.45		28		
	Small Circle 4-11/16" x 4-5/16" x 2-3/8"	8.7			16	1.8		28		
	Half Stone 4-3/4" x 3-5/8" x 2-3/8"	8.4			84	10		28		
	Center Stone 4-3/4" x 3-5/8" x 2-3/8"	9.0			4	0.4		28		
Totals for Cube					280	35.5		1,988		

LAYING A CIRCLE

ROW NUMBER	SMALL CIRCLE	LARGE CIRCLE	HALF STONE	SQUARE STONE	DIAMETER (INCHES)	SEQUENCE
1	8	—	—	—	14-1/8	Next to each other
2	8	—	8	—	23-1/2	SC, HS, SC, HS, etc.
3	—	24	—	—	33	Next to each other
4	—	24	7	1	42-1/2	LC, LC, LC, HS, LC, LC, LC, HS, etc., plus a square at random
5	—	24	16	—	52	HS, LC, HS, LC, LC, HS, LC, HS, LC, LC, etc.
6	—	24	24	—	61-1/2	LC, HS, LC, HS, etc.
7	—	22	23	9	71	LC, HS, LC, HS, Square, LC, HS, LC, HS, Square, etc.

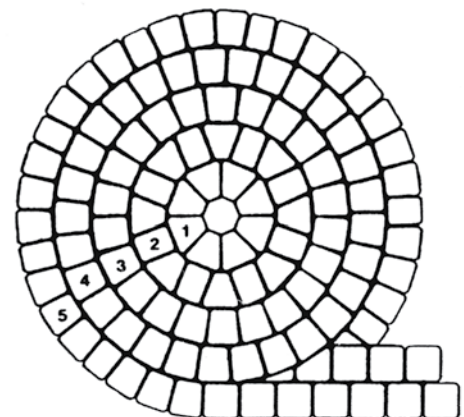

Note: The extra Square Stones left from the Circle Cube can be used to enlarge the circle and to complete your project by themselves or with the stones from the Square/Small Rectangle (SSR) Cube and Large Rectangle (LR) Cube.

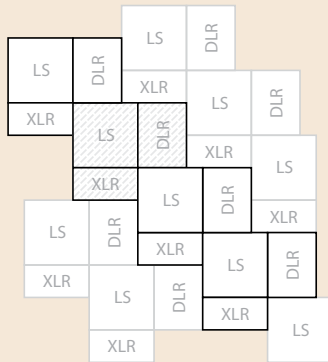

PATTERN 12
1.41 square feet

1 XLR.....	22%
1 DLR.....	34%
1 LS.....	44%

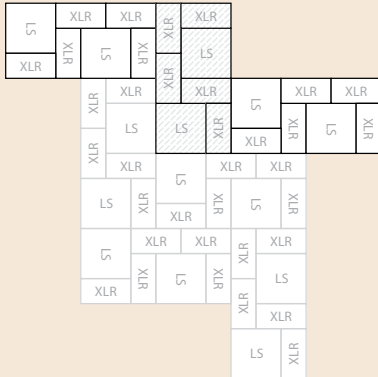

PATTERN 13
2.81 square feet

5 XLR.....	56%
2 LS.....	44%

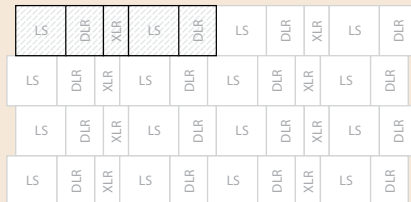

PATTERN 14
2.51 square feet

2 LS.....	50%
2 DLR.....	38%
1 XLR.....	12%

SIDEWALK PATTERNS

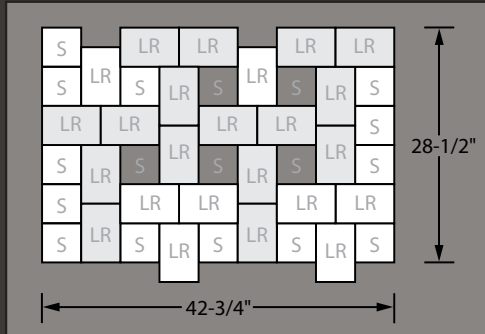

SIDEWALK PATTERN 1
8.48 square feet

18 S.....	33%
24 LR.....	67%

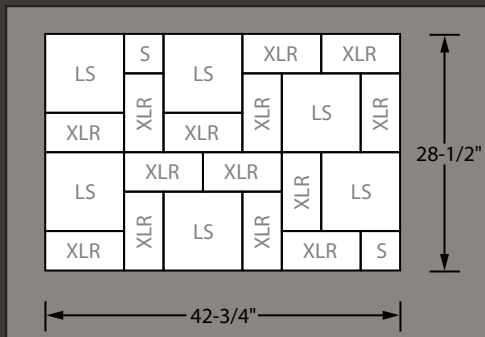

SIDEWALK PATTERN 2
8.48 square feet

2 S.....	4%
14 XLR.....	53%
6 LS.....	43%

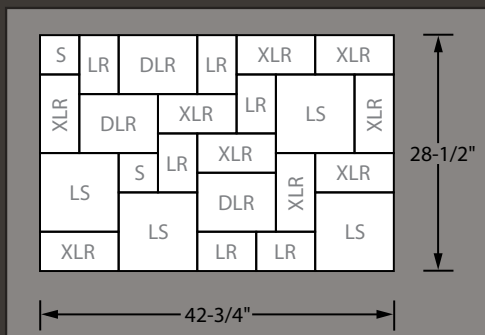

SIDEWALK PATTERN 3
8.48 square feet

2 S.....	4%
6 LR.....	17%
9 XLR.....	33%
3 DLR.....	17%
4 LS.....	29%

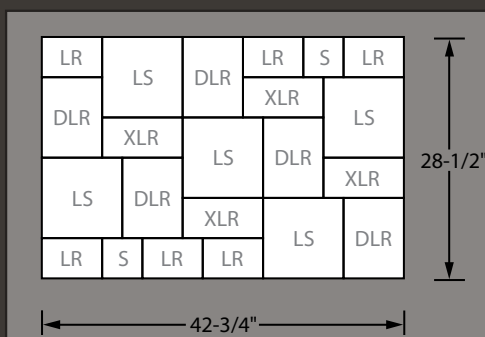

SIDEWALK PATTERN 4
8.48 square feet

2 S.....	3%
6 LR.....	17%
4 XLR.....	15%
5 DLR.....	28%
5 LS.....	37%

	SQ. FT. PER CUBE	UNITS PER SQ. FT.	UNITS PER CUBE	SQ. FT. PER STRAP
Square (O.W. only)	80	6.3	198	8.89
Square/Small Rectangle	80		576	8.89
Large Rectangle	80	4.2	336	13.33
Extra Large Rectangle	90	3.1	280	17.92
Double Large Rectangle	91	2.2	200	18.2
Large Square	97	1.6	160	19.4

HARBOR STONE

PAVERS: HARBOR STONE – IRONWOOD
ACCENT PAVERS: OLD WORLD VINTAGE DLR – SUMMER WHEAT
OLD WORLD VINTAGE XLR – COFFEE



PAVERS: HARBOR STONE – STERLING SMOKE
ACCENT PAVERS: OLD WORLD VINTAGE XLR – JET BLACK
STEP COPING: 3x24 SOFT SPLIT CAP – LIMESTONE BLEND
PORCH COPING: OLD WORLD GLENSTONE – LIMESTONE BLEND



HARBOR STONE

PAVERS: HARBOR STONE – WALNUT BLEND
WALLS: STONEGATE – WALNUT BLEND
CAPS: 3x24 SMOOTH CAP – SLATE



› UPPER PATIO PAVERS: HARBOR STONE – IRONWOOD
LOWER PATIO PAVERS: OLD WORLD VINTAGE – IRONWOOD
ACCENT PAVERS: OLD WORLD VINTAGE XLR – JET BLACK
WALL STONES: GLENSTONE – IRONWOOD
WALL CAPS: OLD WORLD GLENSTONE – SLATE

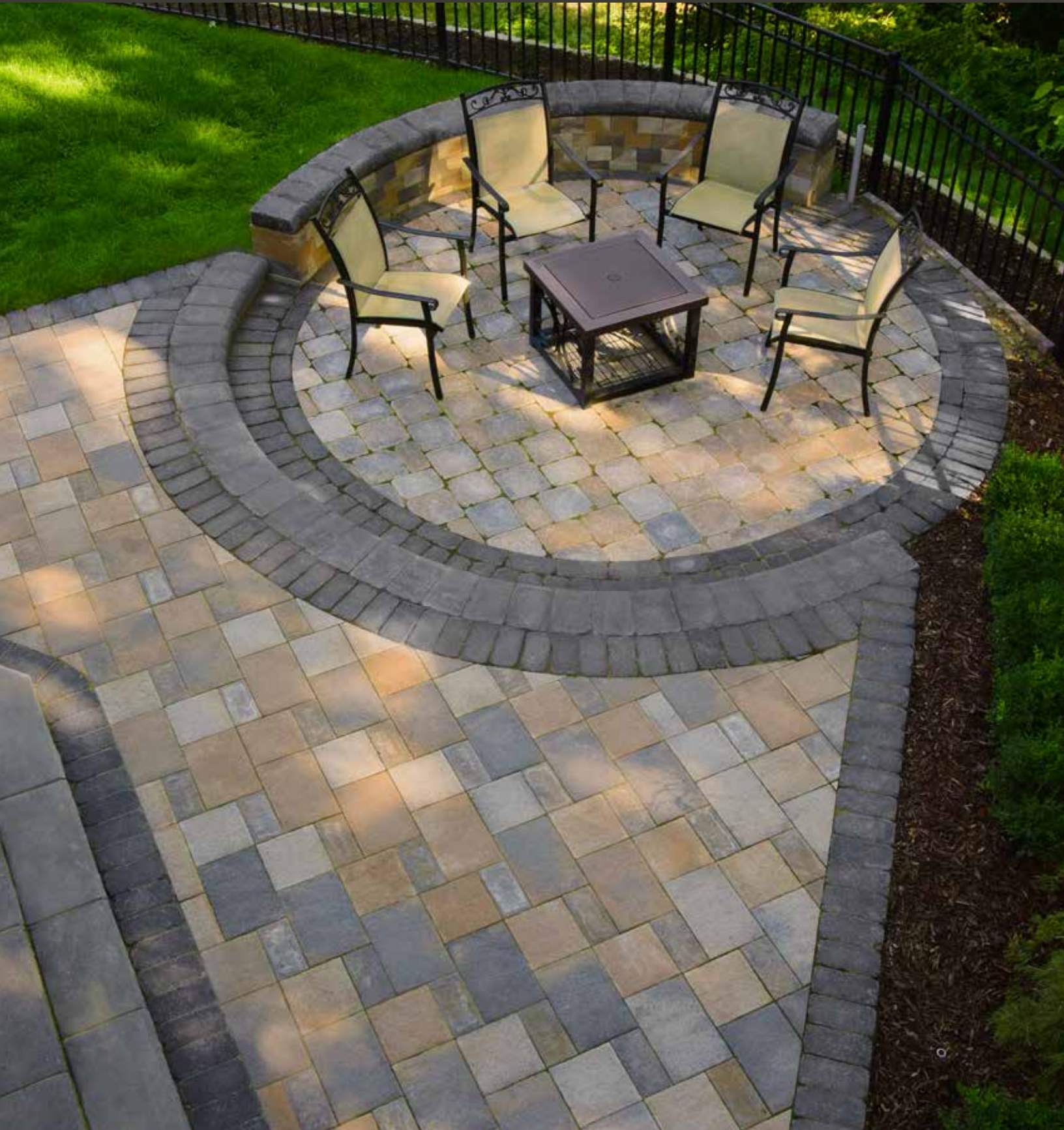

HARBOR STONE

PAVERS: HARBOR STONE – IRONWOOD
ACCENT PAVERS: HOLLAND 4x8 – COFFEE & JET BLACK
WALL STONES: GLENSTONE – LIMESTONE BLEND
STEPS: 3x24 SMOOTH CAP – SLATE



HARBOR STONE & BAY STONE PATTERNS

PAVERS: HARBOR STONE – STERLING SMOKE
ACCENT PAVERS: OLD WORLD VINTAGE XLR – JET BLACK

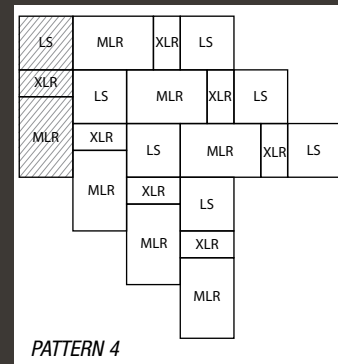
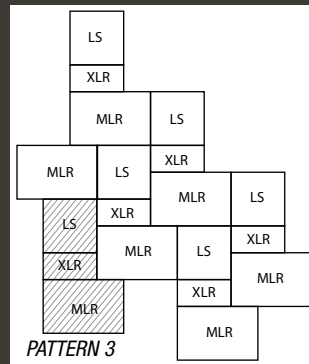
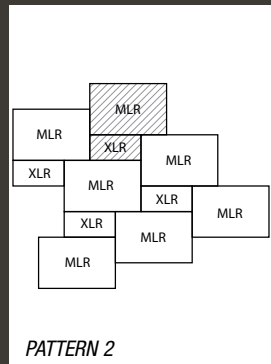
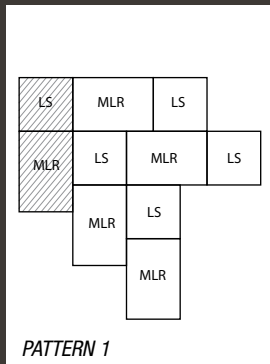



LS – 40%
MLR – 60%

XLR – 25%
MLR – 75%

XLR – 17%
LS – 33%
MLR – 50%

XLR – 17%
LS – 33%
MLR – 50%

		UNITS PER SQ. FT.	UNITS PER LAYER	SQ. FT. PER LAYER	UNITS PER CUBE	SQ. FT. PER CUBE	SQ. FT. PER STRAP	WEIGHT PER SQ. FT.	SOLDIER COURSING LINEAL FOOTAGE	
	Mega Large Rectangle 9-1/2" x 14-1/4" x 2-3/8"	1.06	12	11.25	96	90	30	28		
	Large Square 9-1/2" x 9-1/2" x 2-3/8"	1.65	20	12.1	160	97	19.4	28		
	Extra Large Rectangle 9-1/2" x 4-3/4" x 2-3/8"	3.1	35	11.2	280	90	17.92	28	CUBE	STRAP
									111	22.2

STANDARD COLORS



WALNUT BLEND

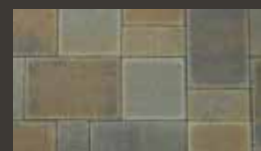

LAKESHORE BLEND

ELITE COLORS



STERLING SMOKE



IRONWOOD

BAY STONE – NEW FOR 2020

➤ AU GRES



PRODUCT INFORMATION

SMOOTH CONTEMPORARY FINISH

60 mm. Series – 3 Sizes

- XLR 9.5" x 4.75"
- LS 9.5" x 9.5"
- MLR 9.5" x 14.25"

Modular with Harbor Stone

XLR also available in Jet Black

➤ MACKINAC



➤ BIRCHWOOD



BAY STONE – NEW FOR 2020

PAVERS: BAY STONE – MACKINAC
FIRE PIT: OLD WORLD GLENSTONE – CHESTNUT
FIRE PIT CAP: 3x24 SMOOTH CAP – SLATE

STANDARD COLORS



BIRCHWOOD



MACKINAC



AU GRES







STANDARD COLORS



RUSTIC BLEND



ANTIQUE BLEND



SANDSTONE BLEND



WALNUT BLEND



LAKESHORE BLEND

ELITE COLORS



STERLING SMOKE

VINTAGE

PAVERS: VINTAGE – SANDSTONE BLEND
STEPS: UNIVERSAL STAIR TREAD – WALNUT BLEND



VINTAGE SERIES



Large Rectangle



Square



Small Rectangle



Half Stone



Small Circle



Large Circle



Center Stone

LARGE RECTANGLE CUBE		UNITS PER SQ. FT.	UNITS PER LAYER	SQ. FT. PER LAYER	UNITS PER CUBE	SQ. FT. PER CUBE	SQ. FT. PER STRAP	WEIGHT PER SQ. FT.	SOLDIER COURSING LINEAL FOOTAGE	
								CUBE		STRAP
	Large Rectangle 7-1/8" x 4-3/4" x 2-3/8"	4.2	42	10.0	336	80	13.33	28	133	22.2

SQUARE & SMALL RECTANGLE CUBE		UNITS PER SQ. FT.	UNITS PER LAYER	SQ. FT. PER LAYER	UNITS PER CUBE	SQ. FT. PER CUBE	SQ. FT. PER STRAP	WEIGHT PER SQ. FT. (LBS.)
<i>(Sold in ratio of 3 squares to 1 small rectangle only)</i>								
	Square 4-3/4" x 4-3/4" x 2-3/8"	6.3	54	8.5	432	68.6	8.89	28
	Small Rectangle 4-3/4" x 2-7/16" x 2-3/8"	12.6	18	1.4	144	11.4		28
<i>Totals for Cube</i>			72		576	80		2,440

CIRCLE CUBE		UNITS PER SQ. FT.	UNITS PER LAYER	SQ. FT. PER LAYER	UNITS PER CUBE	SQ. FT. PER CUBE	SQ. FT. PER STRAP	WEIGHT PER SQ. FT. (LBS.)
<i>(1 circle per cube)</i>								
	Square 4-3/4" x 4-3/4" x 2-3/8"	6.3	14	2.2	56	8.85		28
	Large Circle 4-11/16" x 4-5/16" x 2-3/8"	8.3	30	3.6	120	14.45		28
	Small Circle 4-11/16" x 4-5/16" x 2-3/8"	8.7	4	0.5	16	1.8		28
	Half Stone 4-3/4" x 3-5/8" x 2-3/8"	8.4	21	2.5	84	10		28
	Center Stone 4-3/4" x 3-5/8" x 2-3/8"	9.0	1	0.1	4	0.4		28
<i>Totals for Cube</i>					280	35.5		994

LAYING A CIRCLE

ROW NUMBER	SMALL CIRCLE	LARGE CIRCLE	HALF STONE	SQUARE STONE	DIAMETER (INCHES)	SEQUENCE
1	8	—	—	—	14-1/8	Next to each other
2	8	—	8	—	23-1/2	SC, HS, SC, HS, etc.
3	—	24	—	—	33	Next to each other
4	—	24	7	1	42-1/2	LC, LC, LC, HS, LC, LC, LC, HS, etc., plus a square at random
5	—	24	16	—	52	HS, LC, HS, LC, HS, LC, HS, LC, LC, etc.
6	—	24	24	—	61-1/2	LC, HS, LC, HS, etc.
7	—	22	23	9	71	LC, HS, LC, HS, Square, LC, HS, LC, HS, Square, etc.

Note: The extra Square Stones left from the Circle Cube can be used to enlarge the circle and to complete your project by themselves or with the stones from the Square/Small Rectangle (SSR) Cube and Large Rectangle (LR) Cube.

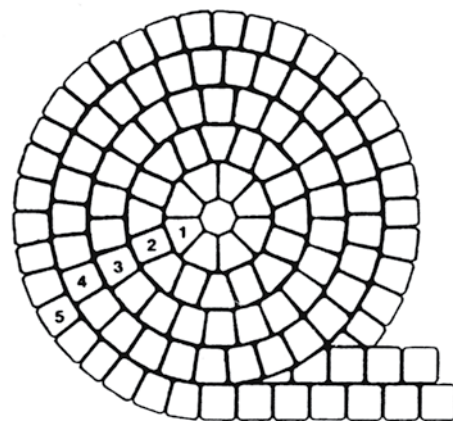

VINTAGE PATTERNS

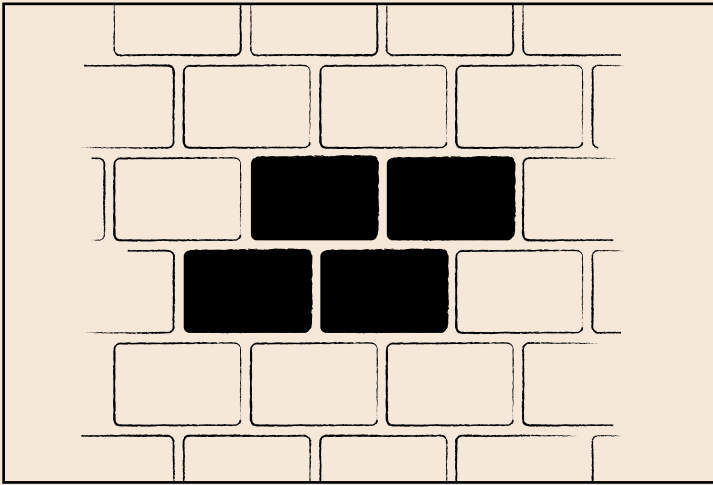

Running Bond

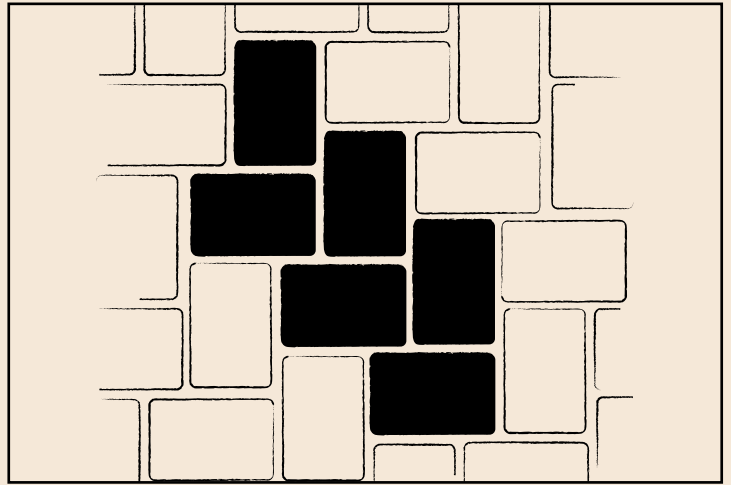

90° Herringbone

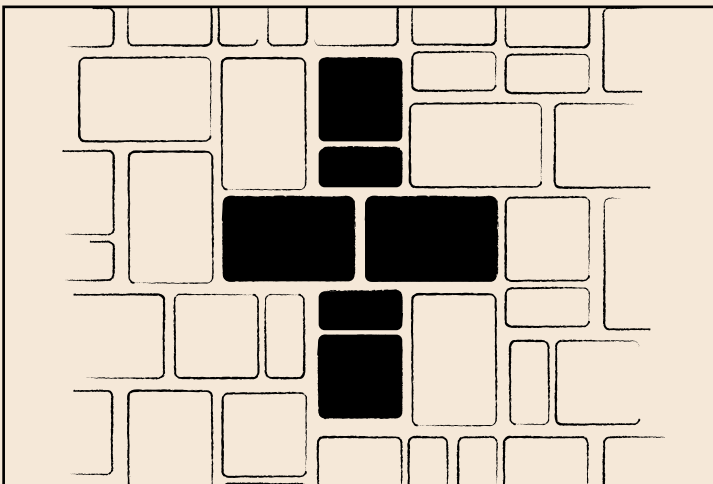

3-Piece Pattern A

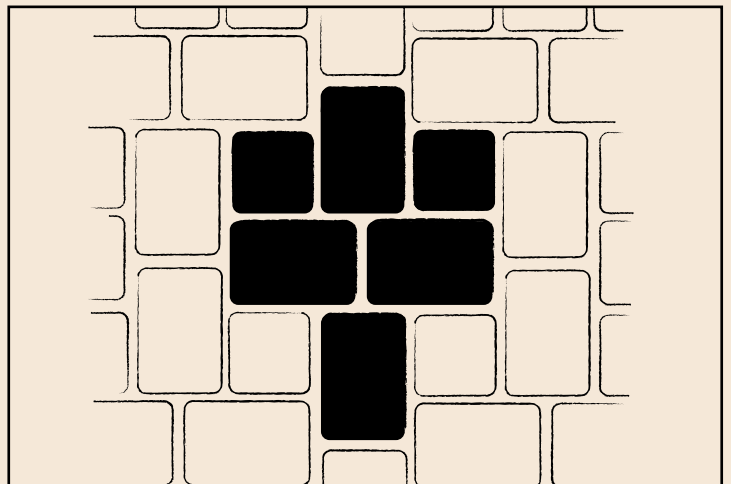

2-Piece Pattern

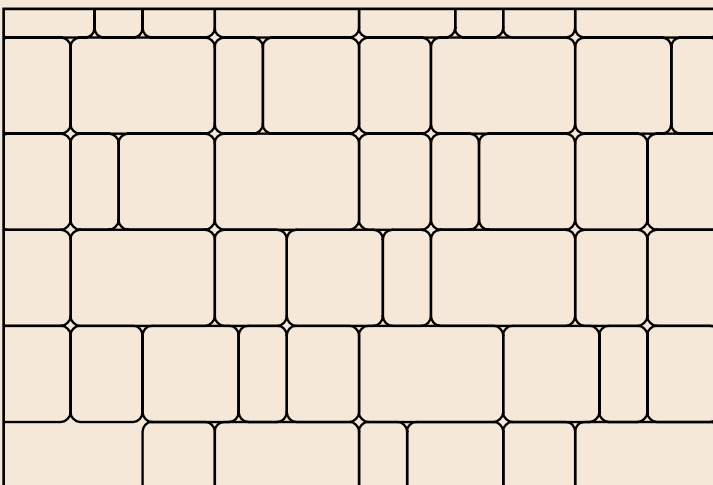

3-Piece Pattern B

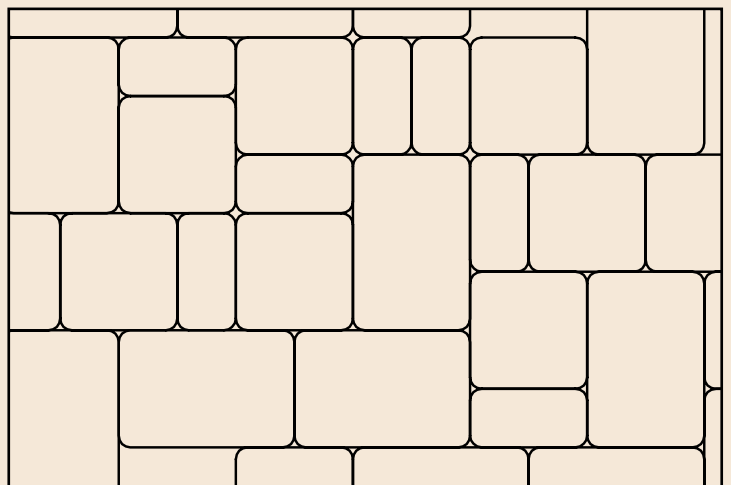

3-Piece Pattern C

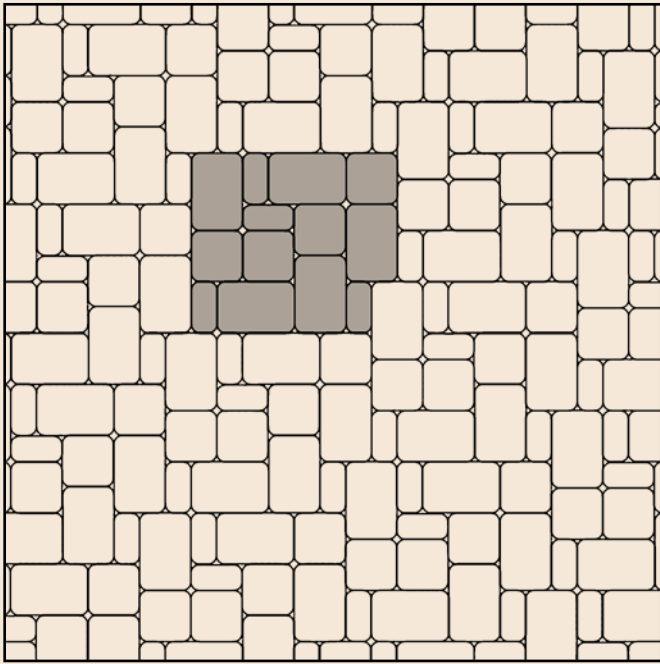

Pattern 3
 $4.62 \times 2.31 = 14.53\%$ (4, Small Rectangles)
 $4.62 \times 4.62 = 29.53\%$ (4, Squares)
 $7.00 \times 4.62 = 55.94\%$ (5, Large Rectangles)

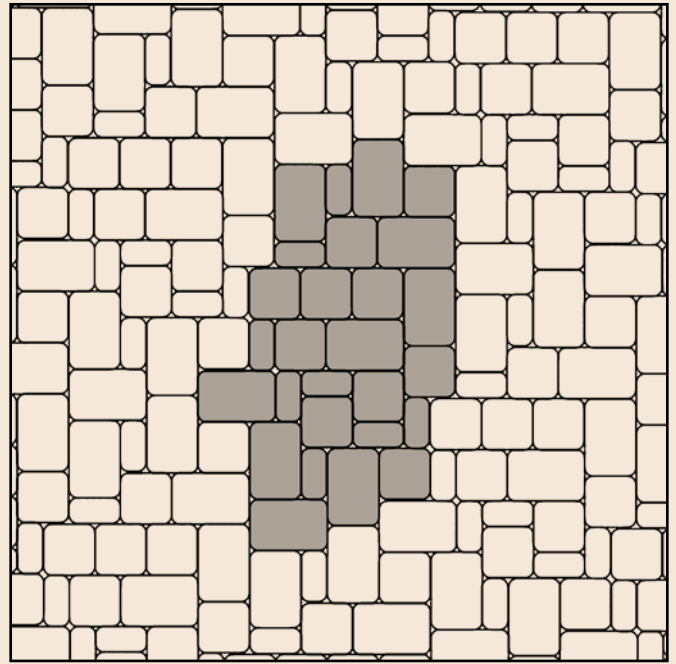

Pattern 4
 $4.62 \times 2.31 = 13.56\%$ (8, Small Rectangles)
 $4.62 \times 4.62 = 36.32\%$ (10, Squares)
 $7.00 \times 4.62 = 50.12\%$ (9, Large Rectangles)

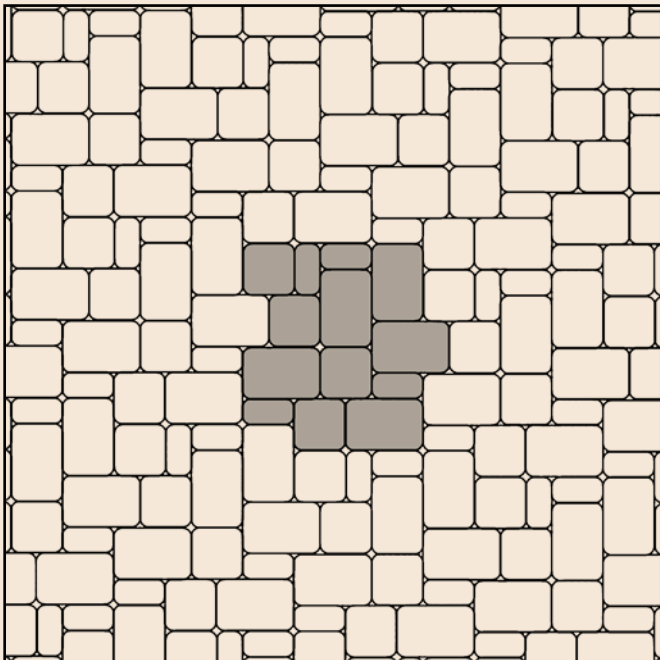

Pattern 5
 $4.62 \times 2.31 = 14.53\%$ (4, Small Rectangles)
 $4.62 \times 4.62 = 29.53\%$ (4, Squares)
 $7.00 \times 4.62 = 55.94\%$ (5, Large Rectangles)

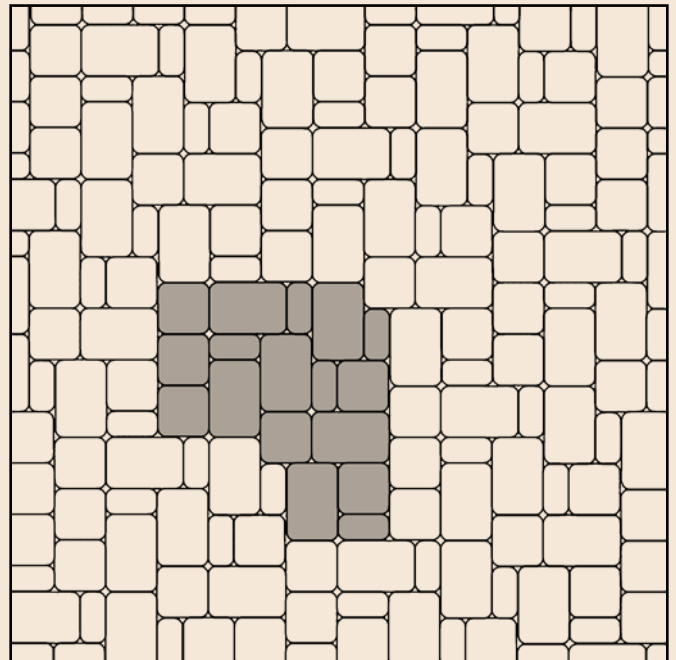

Pattern 6
 $4.62 \times 2.31 = 14.21\%$ (5, Small Rectangles)
 $4.62 \times 4.62 = 34.11\%$ (6, Squares)
 $7.00 \times 4.62 = 51.68\%$ (6, Large Rectangles)

SYMETRY®

▶ NEXT PAGE:
PAVERS: SYMETRY – RUSTIC BLEND
6x6 – CUSTOM COLOR
VENETIAN PARQUET PATTERN



SYMETRY

Units per sq. ft.: 3.4
Sq. ft. per cube: 84
Weight per sq. ft.: 28 lbs.
Weight per cube: 2,352 lbs.
Sq. ft. per strap: 21



6x6 SQUARE

Units per sq. ft.: 4
Sq. ft. per cube: 92
Weight per sq. ft.: 28 lbs.
Weight per cube: 2,576 lbs.
Sq. ft. per strap: 13.14

▶ RIGHT:
PAVERS: SYMETRY VENETIAN PARQUET PATTERN –
RUSTIC BLEND
6x6 – CUSTOM COLOR

▶ BELOW:
PAVERS: SYMETRY VENETIAN PARQUET PATTERN –
ANTIQUE BLEND
6x6 – SLATE

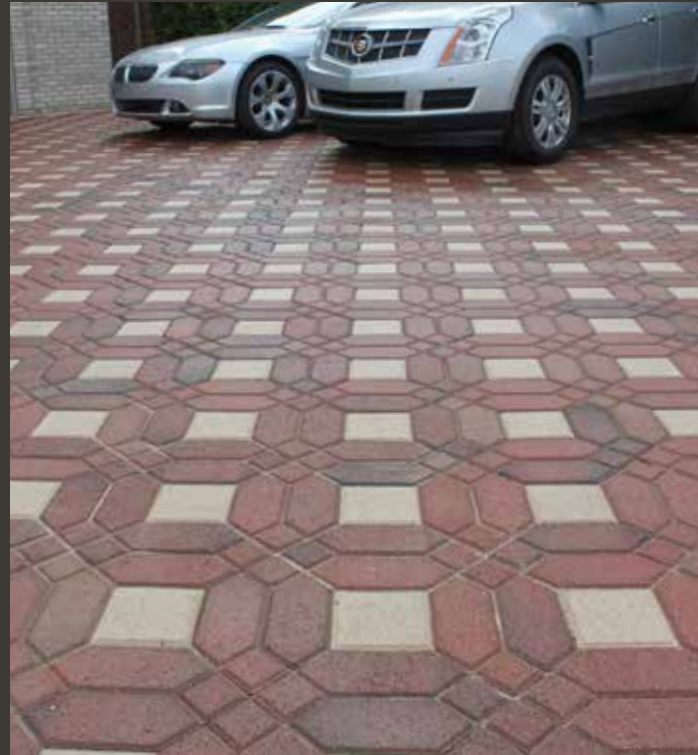



STANDARD COLORS

SYMETRY®



RUSTIC BLEND



ANTIQUE BLEND

6x6



SLATE



SYMETRY® PATTERNS (SHOWN WITH 6x6)

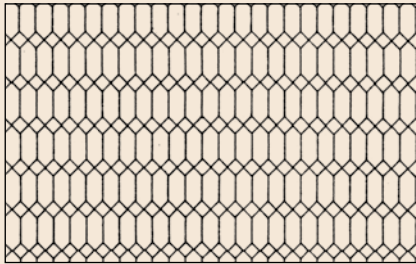

Diamond Run Pattern

100% SYMETRY

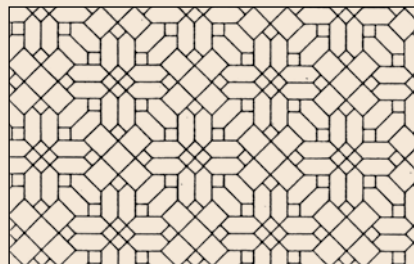

Pattern #7

74.5% SYMETRY 25.5% SQUARES

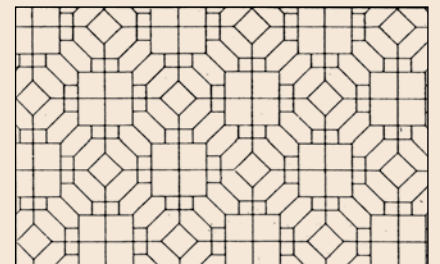

Grand Parquet Pattern

66.2% SYMETRY 33.8% SQUARES

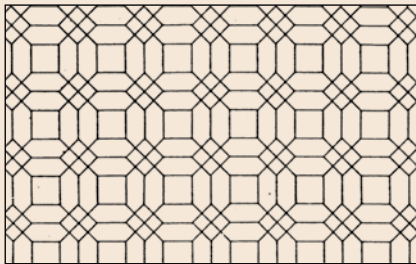

Venetian Parquet Pattern

83% SYMETRY 17% SQUARES

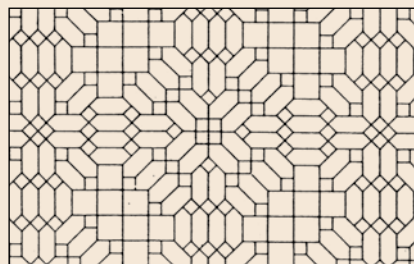

Regency Pattern

83% SYMETRY 17% SQUARES

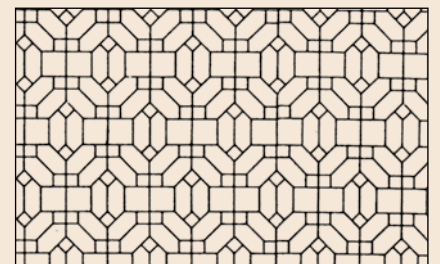

Interpace Pattern

78.5% SYMETRY 21.5% SQUARES

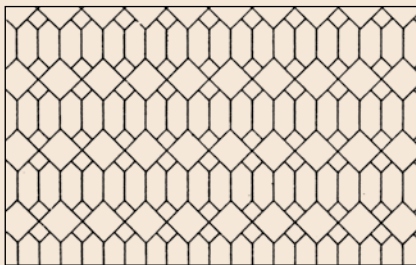

Embassy Row Pattern

71% SYMETRY 29% SQUARES

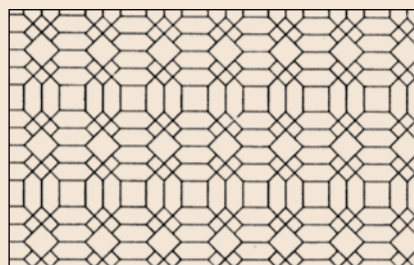

Georgian Parquet Pattern

78.5% SYMETRY 21.5% SQUARES

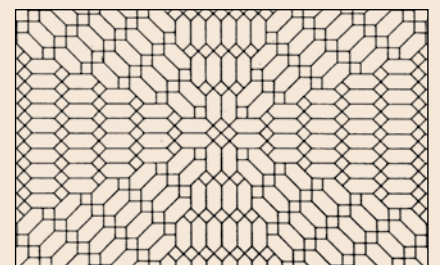

Rondolais Pattern

100% SYMETRY

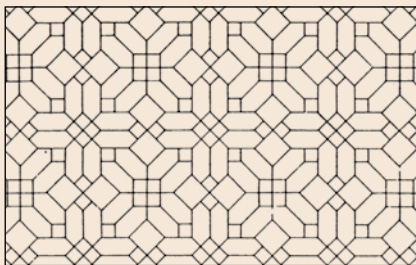

Palace Parquet Pattern

83% SYMETRY 17% SQUARES

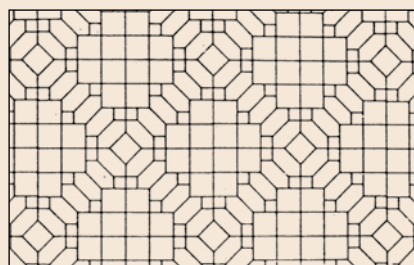

Pattern R.S.

53% SYMETRY 47% SQUARES

*Approximate Scale: 1/4" = 1'
(Percentages in Square Feet)*

HOLLAND 4x8

PAVERS: HOLLAND 4x8 – BURGUNDY BLEND
FIRE PIT: FIRE PIT BLOCK – CAMEL
FIRE PIT CAP: 4" RADIUS GLENSTONE – CAMEL



> PAVERS: HOLLAND 4x8 – POLAR ASH
ACCENT PAVERS: HOLLAND 4x8 – SLATE



HOLLAND 4x8

PAVERS: HOLLAND 4x8 – SUMMER WHEAT
ACCENT PAVERS: HOLLAND 4x8 – COFFEE
STEPS: 3x24 SMOOTH CAP – CHESTNUT



PAVERS: HOLLAND 4x8 – SANDSTONE BLEND
 ACCENT PAVERS: HOLLAND 4x8 – COFFEE
 WALLS: OLD WORLD STONEGATE – SEASHELL BLEND
 CAPS: 3x24 SMOOTH CAP – CHESTNUT

STANDARD COLORS



RED



RUSTIC BLEND



ANTIQUE BLEND



SLATE



SANDSTONE BLEND

ELITE COLORS



IRONWOOD



WHITESTONE



STERLING SMOKE

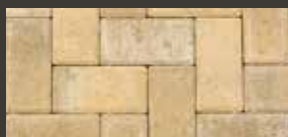

SEASHELL BLEND



POLAR ASH

ELITE COLORS



COFFEE



JET BLACK



SUMMER WHEAT



ALABASTER



GRAYLING

SPECTRUM COLORS



BURGUNDY



SEDONA

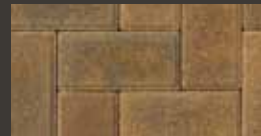

WALNUT BLEND

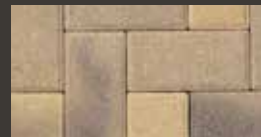

LIMESTONE BLEND



PEWTER



MOSSY OAK BLEND



LAKESHORE BLEND

HOLLAND SERIES

> PAVERS: HOLLAND SERIES – WALNUT BLEND
ACCENT PAVERS: HOLLAND 4x8 – SLATE
BORDER BLOCK: GLENSTONE BULLNOSE – CAMEL
WALLS: VERAZZO STONE – CAMEL
FIRE PIT: VERAZZO STONE – CAMEL



> PAVERS: HOLLAND SERIES – STERLING SMOKE
ACCENT PAVERS: HOLLAND 4x8 – SLATE
WALL STONES: STONEGATE – LIMESTONE BLEND
WALL CAPS: 3x24 SMOOTH CAP – SLATE



HOLLAND SERIES

> PAVERS: HOLLAND SERIES – SANDSTONE BLEND
BORDER PAVERS: HOLLAND 4x8 – COFFEE
WALL STONES: STONEGATE – CAMEL
CAPS & STEPS: 3x24 SMOOTH CAP – CHESTNUT





STANDARD COLORS



SANDSTONE BLEND



WALNUT BLEND

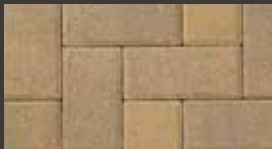

LIMESTONE BLEND



LAKESHORE BLEND

ELITE COLORS



STERLING SMOKE



RIGHT:
PAVERS: HOLLAND SERIES – LIMESTONE BLEND
ACCENT PAVERS: HOLLAND 4x8 – JET BLACK
WALL STONES: STONEGATE – LIMESTONE
CAPS & STEPS: 3x24 SMOOTH CAP – SLATE

HOLLAND 4x8

2-3/8" thick
Units per sq. ft.: 4.5
Sq. ft. per cube: 108
Weight per sq. ft.: 28 lbs.
Weight per cube: 3,024 lbs.
Sq. ft. per strap: 18

HOLLAND 12x12

2-3/8" thick
Units per sq. ft.: 1
Sq. ft. per cube: 72
Weight per sq. ft.: 28 lbs.
Weight per cube: 2,016 lbs.
Sq. ft. per strap: 18

HOLLAND 8x8

2-3/8" thick
Units per sq. ft.: 2.25
Sq. ft. per cube: 96
Weight per sq. ft.: 28 lbs.
Weight per cube: 2,688 lbs.
Sq. ft. per strap: 16

**HOLLAND SERIES
PATTERN** ▶

Approximate %

4" x 8"	24%
8" x 8"	24%
12" x 12"	52%

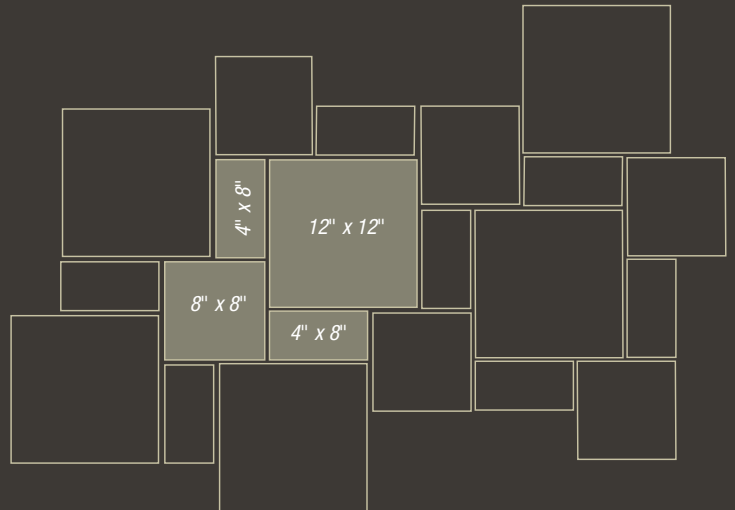

TOP:
PAVERS: HOLLAND SERIES – LAKESHORE BLEND
ACCENT PAVERS: HOLLAND 4x8 – SLATE
WALL STONES: STONEGATE – LIMESTONE BLEND
WALL ACCENT COURSE: STONEGATE – SLATE
CAPS & STEPS: 3x24 SMOOTH CAP – SLATE

BOTTOM:
PAVERS: HOLLAND SERIES – STERLING SMOKE
ACCENT PAVERS: HOLLAND 4x8 – JET BLACK
STEPS COPING: 3x24 SMOOTH CAP – SLATE



STANDARD COLORS

Fendt offers separate color lines at three separate pricing levels, which include Standard Colors, Spectrum Colors and Elite Colors. Fendt's Standard Colors offer some of the widest varieties of both solid colors and blended colors that are available in today's market.



RUSTIC BLEND



WALNUT BLEND



PEWTER



ANTIQUE BLEND



LIMESTONE BLEND



RED



SANDSTONE BLEND



SLATE



LAKESHORE BLEND



MOSSY OAK BLEND

WHEN SELECTING COLOR: The color samples depicted are only a guide to assist in color selection and should not be used to select final color. Actual colors of pavers and walls may vary due to the nature of the raw materials used in processing and the variation of reproduction and printing processes. Final color selection should be made from actual paver and wall products. When installing pavers, use several cubes simultaneously for proper color blending.

SPECTRUM COLORS & ELITE COLORS

Fendt offers two premium color lines, namely Spectrum Colors and Elite Colors. The Spectrum Colors line offers deeper and richer color tones which take standard paver colors to a higher level. The Elite Colors line offers the latest color possibilities when premium colors are combined with premium cements.

SPECTRUM COLORS



BURGUNDY



SEDONA

ELITE COLORS



IRONWOOD



STERLING SMOKE



SEASHELL BLEND



POLAR ASH



WHITESTONE

ELITE COLORS



JET BLACK



COFFEE



SUMMER WHEAT



ALABASTER



GRAYLING

OLD WORLD COLORS

WHEN SELECTING COLOR: The color samples depicted are only a guide to assist in color selection and should not be used to select final color. Actual colors of pavers and walls may vary due to the nature of the raw materials used in processing and the variation of reproduction and printing processes. Final color selection should be made from actual paver and wall products. When installing pavers, use several cubes simultaneously for proper color blending.

STANDARD COLORS



LIMESTONE BLEND



WALNUT BLEND



ANTIQUE BLEND



RUSTIC BLEND



SLATE

ELITE COLORS



POLAR ASH



SUMMER WHEAT



SEASHELL

ACCENT PAVERS — ELITE COLORS

- TOP:
PAVERS: OLD WORLD VINTAGE — SEASHELL BLEND
ACCENT PAVERS: OLD WORLD VINTAGE XLR — RUBY & JET BLACK
- BOTTOM:
PAVERS: OLD WORLD VINTAGE — SEASHELL BLEND
ACCENT PAVERS: OLD WORLD VINTAGE XLR — JET BLACK



JET BLACK

COFFEE



JADE — SPECIAL ORDER

TITANIUM



RUBY

SUEDE



ELITE ACCENT COLORS INVENTORIED IN
OLD WORLD VINTAGE EXTRA LARGE RECTANGLE



CUSTOM COLOR PROJECTS

Looking for something just a little out of the ordinary? While most wall stone and paver products are stocked in a wide range of common colors, Fendt has the capability to produce custom colors on select jobs. Need your driveway pavers a certain shade of gray or even something bolder? Have a special color that is your backyard patio inspiration? Perhaps you just want something no one else has! Fendt understands.





PAVER INSTALLATION INSTRUCTIONS

Interlocking Concrete Paving Stones

1. Prepare the site, making a compacted base with 21AA gravel between 8" and 12" for driveways and with 21AA gravel up to 4" to 6" for patios and walkways. Slope as necessary.
2. Spread a layer of 2NS concrete sand 1" over compacted base. It is important to maintain consistent thickness of bedding sand. Screen the sand to desired level. Allow for thickness of paver and for compaction of sand (approximately ¼" to ½") to be done in step #5.
3. Lay the paving stones in the patterns you choose, starting the edge stones from an existing line such as a curb or house.
4. Make any necessary cutting of stones with a paving stone splitter or masonry saw.
5. Make a minimum of two passes over paving stones with a plate vibrator.
6. Fill the joints by sweeping dry sand over the paving stones, leaving a thin layer for final vibration.
7. Vibrate sand into joints and sweep off excess sand. The pavement is now ready for immediate use.

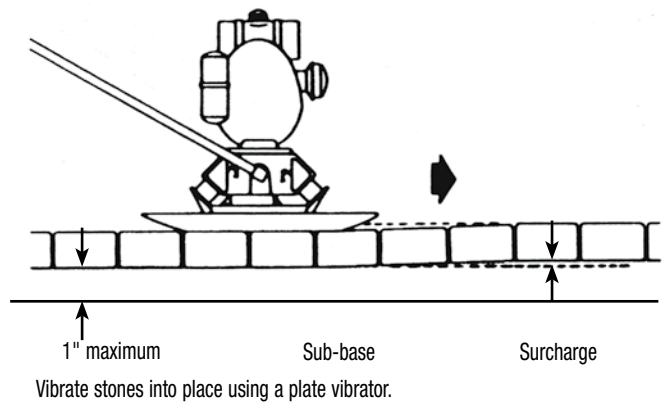
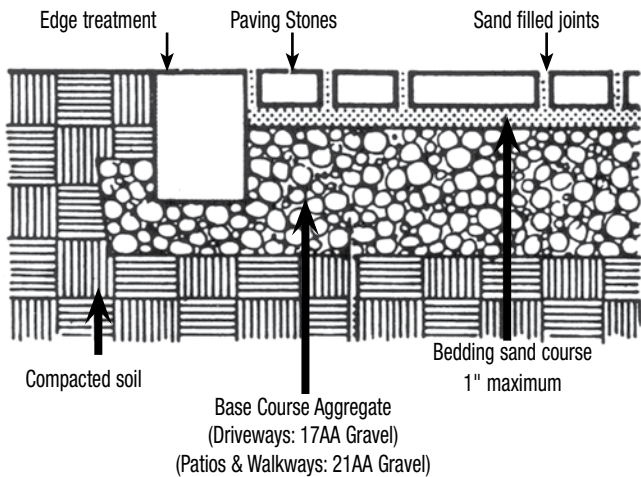

Interlocked Patterns

The Herringbone Patterns

Form the greatest interlock, since the longest continuous joint is only 1-1/2" stones.

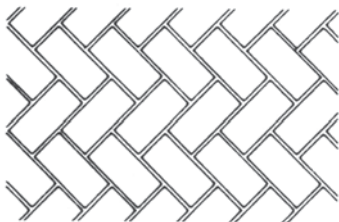

45° Herringbone Pattern

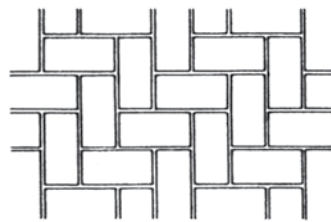

90° Herringbone Pattern

Parquet Pattern

A pattern with unlimited variations.

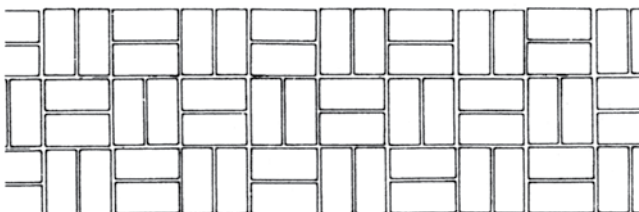

Running Bond Pattern

A traditional pattern that, when used for vehicular traffic, should have traffic crossing the stones' length at right angles.

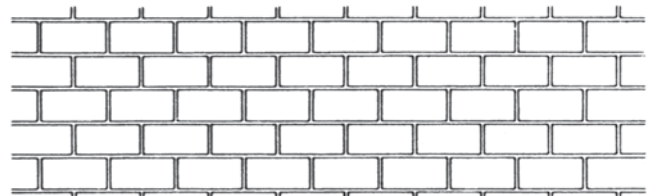

ENVIRONMENTAL PRODUCTS

> CONTENTS

Permeable Pavers	58-61
Monoslab® Grass Paver	62-63
Geolink Erosion Control	64

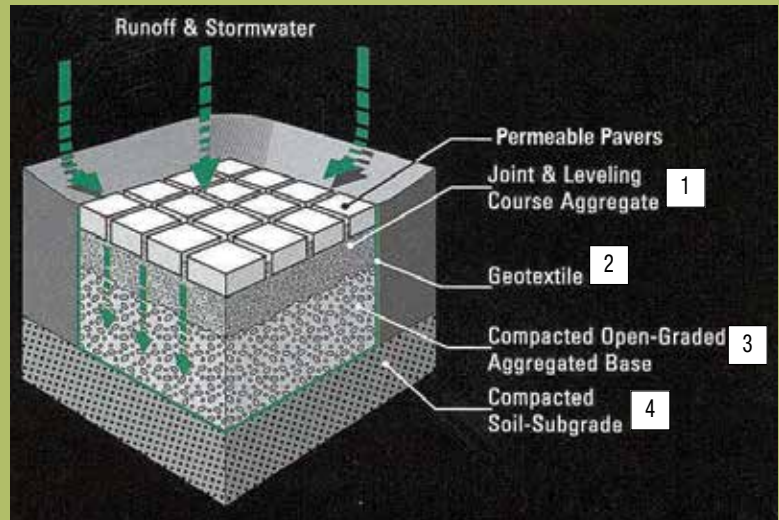

- 1 **JOINT FILLING BEDDING LAYER**
1/8" Crushed Stone Chips @ 1-1/2" Thick
- 2 **GEOTEXTILE**
Non-woven Geotextile Fabric, Minimum 4.0 Ounces Per Square Yard
- 3 **BASE COURSE**
6A Crushed Aggregate @ 6" Minimum Thickness
- 4 **SUBGRADE***
Well Compacted Undisturbed Soil

*Subgrade soil type will determine the need for an outlet from base course to bioswale area. Applicable soil types are fine-grain or impervious soils such as clay. See a qualified Fendt representative for bioswale applications.

Permeable pavements now offer a new dimension by allowing a higher percentage of rainwater to permeate through the pavement system as opposed to overburdened storm water systems. When installed as part of the Bio-Aquifer Storm System (BASS), permeable pavers allow for natural storm water drainage and ground water recharge, making them ecologically sound and economically smart.

A parking lot or street created with BASS uses durable, permeable components that allow water to flow through, retaining the water runoff and directing it through a series of natural filtration systems before it enters nearby streams or rivers. Fendt's Eco-Brick™ and Eco-Classic are the perfect solution that can transform any paver parking lot, driveway or pavement area into a beautiful and sustainable pavement that effectively manages storm water.

PERMEABLE PAVERS: ECO-CLASSIC

Eco-Classic

PRODUCT INFORMATION

FULL BRICK
4-1/2" x 9" x 3-1/8"
.272 sq. ft. per unit
3.68 units per sq. ft.
36 units/layer, 252/cube

HALF BRICK
4-1/2" x 4-1/2" x 3-1/8"
.136 sq. ft. per unit
7.35 units per sq. ft.
8 units/layer, 56/cube

10.9 sq. ft. per layer
76.30 sq. ft. per cube

Weight per cube: 2,719 lbs.



ECO-CLASSIC
INVENTORIED IN LIMESTONE BLEND (ABOVE) AND WALNUT BLEND

Old World Eco-Classic (SPECIAL ORDER)

PRODUCT INFORMATION

FULL BRICK
4-1/2" x 9" x 3-1/8"
.272 sq. ft. per unit
3.68 units per sq. ft.
36 units/layer, 252/cube

HALF BRICK
4-1/2" x 4-1/2" x 3-1/8"
.136 sq. ft. per unit
7.35 units per sq. ft.
8 units/layer, 56/cube

10.9 sq. ft. per layer
76.30 sq. ft. per cube

Weight per cube: 2,719 lbs.



OLD WORLD ECO-CLASSIC

PERMEABLE PAVERS: ECO-CLASSIC

PAVERS: ECO-CLASSIC – WALNUT BLEND



PERMEABLE PAVERS: ECO-CLASSIC

PAVERS: ECO-CLASSIC – SANDSTONE BLEND
ACCENT PAVERS: ECO-CLASSIC – JADE



PERMEABLE PAVERS: ECO-BRICK™ (SPECIAL ORDER)

ECO-BRICK – LIMESTONE BLEND
BORDER: HOLLAND 4x8 – SLATE



PRODUCT INFORMATION



FULL BRICK
4-1/2" x 9" x 3-1/8"
.272 sq. ft. per unit
3.68 units per sq. ft.
36 units/layer, 252/cube

HALF BRICK
4-1/2" x 4-1/2" x 3-1/8"
.136 sq. ft. per unit
7.35 units per sq. ft.
8 units/layer, 56/cube



GRASS PAVERS: MONOSLAB®

MULTI-PURPOSE MONOSLAB GRASS PAVER ... THE PROBLEM SOLVER!

STABILIZES GRASSY AREAS:

- FOR FIRE LANES
- HIGHWAY CROSSOVERS
- RUNWAY SHOULDERS

It's the natural look in paving ... proven over three decades in use. Monoslab Grass Pavers allow a lawn area to be used for parking or driveways — preserving green space in places where it's scarce.

Monoslab Grass Pavers eliminate the dust or mud normally created by allowing traffic in unpaved areas, and can be used in any area where you want to allow vehicular traffic while preserving the look of a lawn.

The unique design of Monoslab affords better weight distribution and increased load bearing capacity. The surface pattern encourages controllable drainage, while stimulating grass growth.

Fast and simple to install in any weather, Monoslab Grass Pavers are available for immediate use.

Monoslab Grass Paver grids permit emergency vehicles and fire trucks to approach buildings from all directions saving time and possibly lives. Heavy trucks drive over stabilized grassy areas leaving no trace.

When considering the areas around apartments and other commercial buildings, the design professional has an alternative to traditional asphalt and other hard surfacing. Monoslab is not subject to most restrictive zoning ordinances that cover hard pavement.

Monoslab grids enable emergency and surface vehicles to cross over between concrete and asphalt pavements.

Especially suitable at curves, concrete grids are readily seen at night. Fast, easy installation. Tire rumbling when driving over the concrete grids alerts drivers.



GOOD NEWS FOR FIREFIGHTERS, LANDSCAPE ARCHITECTS & HIGHWAY/WATERWAY ENGINEERS

SAVES GRASS ... The design professional now has an exciting option when considering surfacing for areas around apartment buildings, shopping malls, office buildings and other urban developments. Monoslab offers a relief from traditional hard surfacing by introducing stabilized grass areas. Suitable for parking lots and overflow parking areas, it will also allow utility trucks to drive over landscaped grounds.

STOPS EROSION ... Monoslab is the best answer to stabilize slopes and put an end to persistent erosion problems. Even river bed erosion in fast-flowing rivers or open culverts can be effectively controlled with Monoslab.

It is also successfully used as revetments to reinforce reservoirs and shoreline slopes and to provide seawall toe protection. After Monoslab is laid and grass established, an installation can be mowed as normal grass.



MONOSLAB® GRASS PAVERS

EASY TO INSTALL



STEP 1

For heavy loads, bulldoze one foot below finished grade.

For light loads (automobiles), bulldoze one-half foot below finished grade.



STEP 4

Level the paver grids on the sand bed. Keep them "pencil thickness" apart.



STEP 2

For light loads, spread and tamp — or roll — one inch sand bed directly on the sub-grade.



STEP 5

Ready for service.

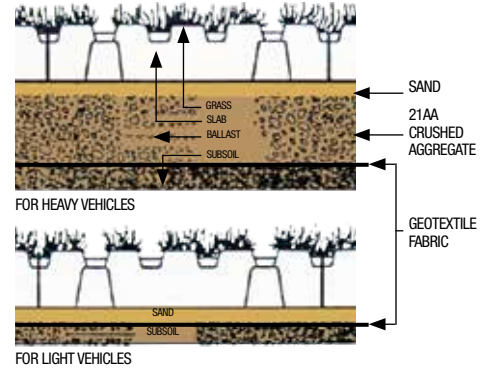

STEP 3

For heavy loads (trucks), spread and tamp — or roll — six inches of crushed rock or crushed concrete over continuous geotextile fabric for heavy vehicle base course. Not required for light loads, such as automobiles.

Spread and tamp — or roll — one-inch sand bed on the six-inch ballast course.

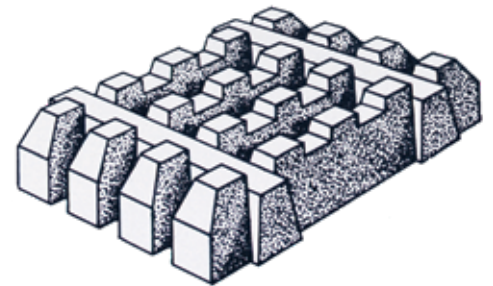

SO MANY BENEFITS:

- Minimize storm water runoff
- Replenish subterranean ground water
- Avoid erosion and soil wash away
- Protect lawns from wheel tracks
- Reduce hard surface pavement

All of the above objectives can be accomplished by installing Monoslab. On a test installation of tufted Grass Paver bedded on two inches of coarse sand spread over six inches of gravel, with clay subsoil, no water ran off for an hour. Storm water runoff then ranged from 5% to 18%.

SPECIFICATIONS

MEASUREMENTS	USA/CAN actual	USA/CAN nominal	USE NOMINAL VALUES FOR COMPUTATIONS
Length	23-1/2"	24 in. - 2 ft.	+/- 1/8"
Width	15-3/8"	16 in. - 1-1/3 ft.	+/- 1/8"
Thickness	4-9/16"	4-1/2 in. - 3/8 ft.	+/- 1/16"
Area, gross	370 sq. in.	2-2/3 sq. ft.	3 grids = 8 sq. ft.
Area, upper surface	95 sq. in.	2/3 sq. ft.	25% of gross area
Area, base surface	326 sq. in.	2-1/2 sq. ft.	85% of gross area
Weight/grid	94 lb. +/- 3 lbs.	94 lbs.	depends on water absorption
Strength, compression	4000 psi	4000 psi	per ASTM C140-70
Braking load, transverse	-	-	see specification and test procedure sheets
Absorption, water	13 lbs. / cu. ft.	13 lbs. / cu. ft.	per ASTM C140-70

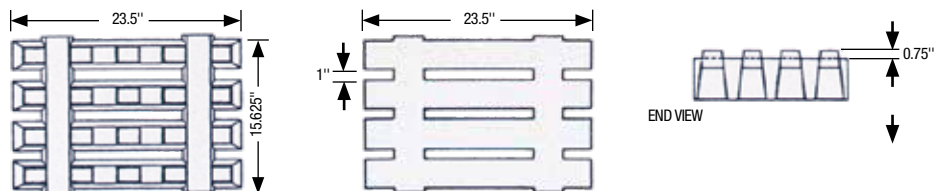

GEOLINK



Soil erosion has been an issue plaguing engineers for decades. It is a well-known fact that the single biggest impact on water quality is the soil erosion process. As a result of new federal and local regulations mandating the control of silt runoff, the engineering community must now use innovative measures to control the erosion process.

Geolink's premium design inhibits the transport of soil during the erosion process and helps keep our waterways free from silt and hazardous pollutants. Open cells within the block support and maintain vegetative growth, enhancing water quality through a natural cleansing process by filtering out contaminants. Geolink's superior methods of erosion control promote a natural, aesthetically pleasing environment.

G E O L I N K Unit Specifications							
height	width	length	gross coverage per ft ²	weight	weight per sq ft	open area %	
4"	12"	16"	1.12	36.6	32-37	20	
UNITS PER PALLET – 48				WEIGHT PER PALLET – 1,469 LBS.			



PERMEABLE GRASS PAVER

- Geolink units with vegetation
- Soil-filled units
- Engineering fabric layer
- Drainage media
- Prepared subgrade foundation

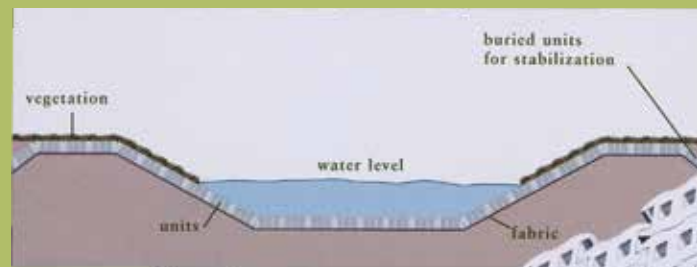
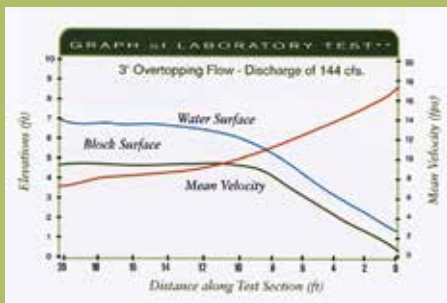

WALL STONES

WALLS: OLD WORLD STONEGATE – LIMESTONE BLEND
ACCENT WALL COURSE: OLD WORLD STONEGATE – SLATE
CAPS: 3x24 SMOOTH CAPS – LIMESTONE BLEND

CONTENTS

Garden Wall	66
Glenstone	67
Old World Glenstone	68
Old World Glenstone Bullnose	69
Verazzo Stone	70-73
Murino	74-75
Stonegate	76-79
Old World Stonegate	80-81
Caps & Steps	82
Piers	83
Design Details	84-85
Wall Caps & Stair Treads	86-87
Coping Stone	88
Old World Glenstone Bullnose	89
Fire Pit Block	90-91
Keystone Compac Hewnstone	92-95
Keystone Straight Split	96-97
Keystone Sculptured Split	98-99
Design Details & Charts	100-103
Installation Instructions	104
Landscape Wall Colors	105
Reference Guide	106-107

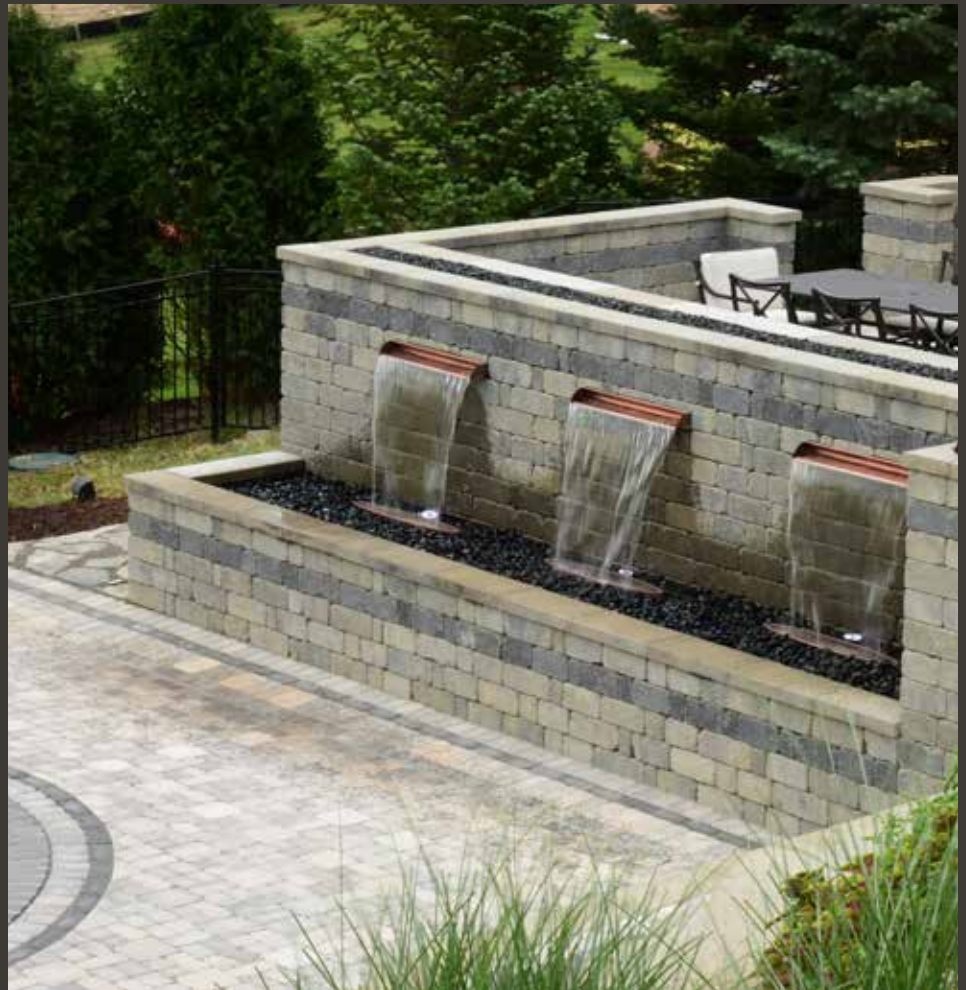

The perfect way to complete your hardscape project is with Fendt concrete wall stones. We feature the Keystone Retaining Wall product line, which has been recognized as the leader in Segmental Retaining Walls (SRWs).

This same style, technology and performance that engineers have specified for years is now available in a wide range of colors and designs to fit your every need and situation. With various styles of wall stones to choose from, your yard can become a showcase to satisfy every possible design.

Fendt's history and experience with colors in concrete pavers is now yours to expand your design options when utilizing retaining walls, courtyard walls, piers and fire pits. As you consider the right wall product to use to complement the rest of your hardscape design, let yourself dream in color!

GARDEN WALL



LIMESTONE BLEND



RUSTIC BLEND



DESERT BROWN



ANTIQUÉ BLEND



WALNUT BLEND



GREY



SLATE



RED



GOLDEN ROD

When it's time to create the garden of your dreams, Fendt offers a full line of Garden Wall brand wall stones to create the elegant and unique look you want. Garden Wall products come in a wide variety of exceptional colors. With their three-dimensional, textured appearance, they add an element of rugged perfection to any garden project.



(Unit shown upside-down to show rear lug)



➤ RIGHT:
KEYSTONE GARDEN WALL –
RUSTIC BLEND

Removing rear lugs when building curves

To remove outside lugs or edges of retaining lip, hold unit securely or place at angle on ground. Strike the lug firmly with a hammer. Always wear safety glasses to protect eyes from chips.



Size: 4" h x 12" w x 8" d
Exposed face area: 1/3 sq. ft. (4" x 12")
Weight: 25 lbs.
Units per pallet: 96 units
Weight per pallet: 2,400 lbs.

Typical Landscape Wall Section Shown at Right

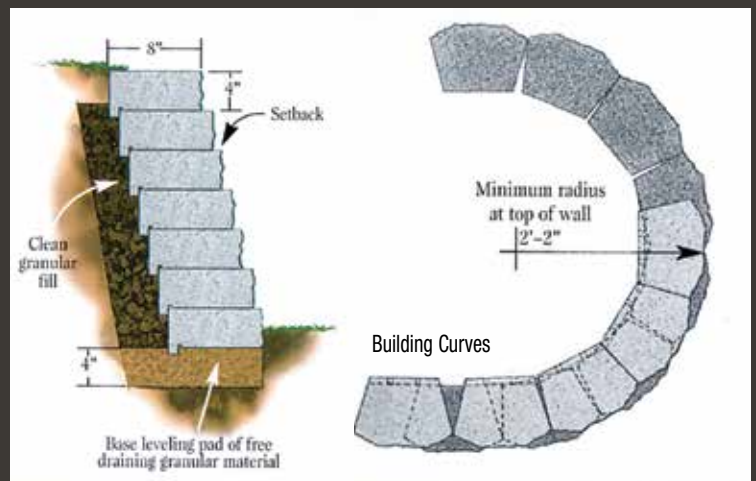

GLENSTONE

> WALL STONES: GLENSTONE – SLATE
 WALL ACCENT COURSE: OLD WORLD VINTAGE XLR – COFFEE
 WALL CAPS: GLENSTONE BULLNOSE – SLATE
 PIERS: GLENSTONE – LIMESTONE BLEND
 PIER ACCENT COURSE: OLD WORLD VINTAGE XLR – COFFEE



STANDARD COLORS



WALNUT BLEND



SLATE



RUSTIC BLEND



CAMEL



GREYSTONE



LIMESTONE BLEND

SPECTRUM COLORS



BURGUNDY BLEND



CHESTNUT

ELITE COLORS



IRONWOOD



STERLING SMOKE



ALABASTER



GRAYLING



Old World 4" Radius Glenstone

- Size: 4" h x 8" d x 12-1/4" / 9-1/8" w
- Use with Glenstone to Turn Radius
- No Cutting Required – 16 Units per Circle
- Weight: 27.55 lbs.
- Units per pallet: 96 units
- Weight per pallet: 2,645 lbs.
- Stock Colors: Walnut, Rustic, Limestone, Camel, Slate



Glenstone / Old World Glenstone

- Size: 4" h x 8" d x 12" w
- Exposed face area: 1/3 sq. ft. (4" x 12")
- Weight: 32 lbs.
- Units per pallet: 96 Units
- Weight per pallet: 3,072 lbs.

STANDARD COLORS



O.W. WALNUT BLEND



O.W. SLATE



O.W. RUSTIC BLEND



O.W. CAMEL



O.W. GREYSTONE



O.W. LIMESTONE BLEND



O.W. BURGUNDY BLEND

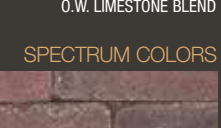

O.W. CHESTNUT



O.W. IRONWOOD

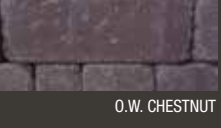

O.W. STERLING SMOKE



O.W. ALABASTER



O.W. GRAYLING

OLD WORLD GLENSTONE

- > TOP:
 - WALLS: OLD WORLD GLENSTONE – WALNUT BLEND
 - ACCENT COURSE: OLD WORLD GLENSTONE – SLATE
 - FIRE PIT: OLD WORLD FIRE PIT – WALNUT BLEND
 - FIRE PIT CAP: OLD WORLD 4" RADIUS GLENSTONE
- > BOTTOM:
 - WALL STONES: OLD WORLD GLENSTONE – IRONWOOD
 - WALL ACCENT COURSE: GLENSTONE – SLATE



OLD WORLD GLENSTONE BULLNOSE

- TOP:
STEP COPING: OLD WORLD GLENSTONE BULLNOSE – WALNUT BLEND
PAVERS: HOLLAND SERIES – WALNUT BLEND
ACCENT PAVERS: OLD WORLD VINTAGE XLR – JET BLACK
- BOTTOM:
WALLS: VERAZZO STONE – CAMEL
STEP COPING: GLENSTONE BULLNOSE – CAMEL
WALL ACCENT COURSE: GLENSTONE – SLATE
PAVERS: HOLLAND SERIES – WALNUT BLEND
ACCENT PAVERS: HOLLAND 4x8 – SLATE



O.W. WALNUT BLEND



O.W. LIMESTONE BLEND

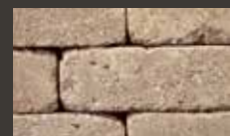

O.W. CAMEL



O.W. SLATE



KEYSTONE VERAZZO STONE™

OUTDOOR KITCHEN WALL: VERAZZO STONE – CAMEL
WALL ACCENT COURSE: VERAZZO STONE – CHESTNUT
SITE WALL: HEWN STONE – WALNUT BLEND
PAVERS: HOLLAND SERIES – WALNUT BLEND



WALLS: VERAZZO STONE – CAMEL
CAPS: GLENSTONE – CAMEL
FIRE PIT: VERAZZO STONE – CAMEL
FIRE PIT CAP: GLENSTONE BULLNOSE – CAMEL
PIER ACCENT COURSE: GLENSTONE – SLATE
PAVERS: HOLLAND SERIES – WALNUT BLEND
ACCENT PAVERS: HOLLAND 4x8 – SLATE



KEYSTONE VERAZZO STONE™

PIERS: VERAZZO STONE – WALNUT BLEND
 PIER ACCENT COURSE: GLENSTONE – SLATE
 PAVERS: HOLLAND SERIES – WALNUT BLEND



STANDARD COLORS



WALNUT BLEND



RUSTIC BLEND



LIMESTONE BLEND



SLATE



CAMEL

SPECTRUM COLOR



CHESTNUT

ELITE COLOR



GRAPHITE BLEND



With unmatched strength and stability, Keystone Verazzo Stone™ has rugged good looks and aesthetic appeal. Each Keystone Verazzo Stone™ is angled on both sides providing different face lengths for a tight fitting, straight wall. Aligning units is also effortless due to the Keystone proven pin connection system. Each stone contains multiple pin positions allowing for a nearly vertical or offset wall.

Keystone Verazzo Stone™ looks like a natural element in your yard because each unit is finished on two sides.

Size.....6" h x 16" / 12" w x 10-1/2" d
 Exposed face area.....0.58 sq. ft. (avg.)
 Weight.....73 lbs.
 Units per pallet.....45 units
 Weight per pallet.....3,272 lbs.
 Pins.....2/block, 50/bag

Verazzo Pin



18 Pieces
 93" O.D.
 71" I.D.

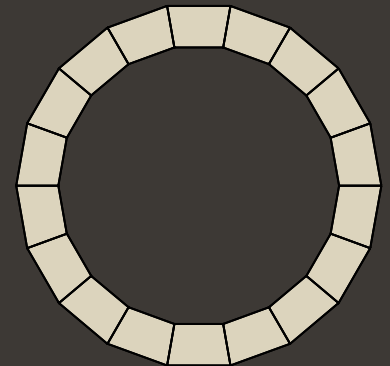

VERAZZO RETURN CORNER

BELOW:
VERAZZO STONE – CAMEL

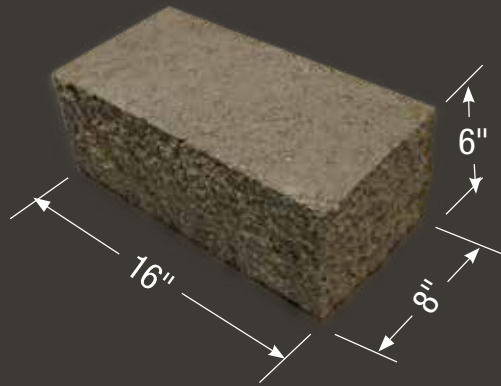

Verazzo Return Corner



Corner Construction



24" x 24" Pier
Utilizing 4-Return Corners



KEYSTONE MURINO

› TOP:
WALLS: MURINO – GRAPHITE BLEND
ACCENT WALL COURSE: MURINO – WALNUT BLEND
SEAT WALL: GLENSTONE BULLNOSE – WALNUT BLEND
CAPS: 3x24 SMOOTH CAP – SLATE
PAVERS: HOLLAND SERIES – WALNUT BLEND

› BOTTOM:
WALLS: MURINO – WALNUT BLEND
SHELF COURSE: UNIVERSAL CAP – CHESTNUT
CAPS: 3x24 SMOOTH CAP – CHESTNUT



MURINO™ WALL SERIES

SMALL UNIT

6”h x 6”/4”w x 10”d
22 lbs.



LARGE UNIT

6”h x 16”/14”w x 10”d
58 lbs.



SHOULDERED OR DOM PINS
2 PER UNIT

2-PIECE SET – LARGE & SMALL UNIT
3-SIDED INTERLOCKING TEXTURED FINISH
MODULAR WITH STONEGATE SERIES
NATURAL “HEWNSTONE” STYLE FACE
UTILIZES KEYSTONE’S PROVEN PIN SYSTEM

Set size | 6”h x 10”d x 20”w
Exposed face area | 0.83 sq. ft.
Weight/set | 80 lbs.
Sets per pallet | 30
Weight per pallet | 2,470 lbs.

STANDARD COLORS



WALNUT BLEND



LIMESTONE BLEND

ELITE COLORS



GRAPHITE BLEND

KEYSTONE STONEGATE

› WALLS: STONEGATE – WALNUT BLEND
CAPS: 3x24 CAP – SLATE
FIREPLACE: STONEGATE – WALNUT BLEND



WALLS: STONEGATE – SLATE
WALL CAPS (foreground): 3x24 SMOOTH CAP – LIMESTONE BLEND
PAVERS: OLD WORLD VINTAGE – POLAR ASH
FIRE PIT: FIRE PIT BLOCK – SLATE



KEYSTONE STONEGATE

- › TOP:
WALLS: STONEGATE – SLATE
WALL CAPS & STEPS: 3x24 SMOOTH CAP – LIMESTONE BLEND
- › BOTTOM:
WALLS: STONEGATE – WALNUT BLEND
CAPS: 3x24 SMOOTH CAPS – WALNUT BLEND



KEYSTONE STONEGATE

WALLS: STONEGATE – SLATE
 WALL ACCENT COURSE: STONEGATE – LIMESTONE BLEND
 WALL CAPS: 3x24 SMOOTH CAP – LIMESTONE BLEND



STANDARD COLORS



RUSTIC BLEND



WALNUT BLEND

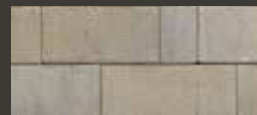

LIMESTONE BLEND

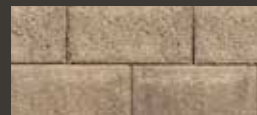

CAMEL

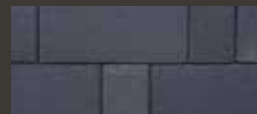

SLATE

ELITE COLORS



GRAPHITE BLEND

Set size 6" h x 10" d x 32" w max.
 Exposed face area 1.4 sq. ft. max.
 Weight/set 137 lbs.
 Sets per pallet 20
 Weight per pallet 2,788 lbs.

LARGE UNIT

60 lbs. (27 kg)
 6" h x 10" d x 16" / 14" w
 (150mm x 250mm x 400mm/350mm)



MEDIUM UNIT

40 lbs. (18 kg)
 6" h x 10" d x 12" / 10" w
 (150mm x 250mm x 300mm/250mm)



SMALL UNIT

25 lbs. (11 kg)
 6" h x 10" d x 6" / 4" w
 (150mm x 250mm x 150mm/100mm)



KEYSTONE OLD WORLD STONEGATE

WALLS: OLD WORLD STONEGATE – WALNUT BLEND
CAPS: 3x24 CAP – GREYSTONE



KEYSTONE OLD WORLD STONEGATE

WALLS: OLD WORLD STONEGATE – LIMESTONE BLEND
ACCENT WALL COURSE: OLD WORLD STONEGATE – SLATE
CAPS: 3x24 SMOOTH CAP – LIMESTONE BLEND



STANDARD COLORS



O.W. RUSTIC BLEND



O.W. WALNUT BLEND



O.W. LIMESTONE BLEND



O.W. CAMEL



O.W. SLATE

ELITE COLORS



O.W. GRAPHITE BLEND

Set size 6" h x 10" d x 32" w max.
Exposed face area 1.4 sq. ft. max.
Weight/set 137 lbs.
Sets per pallet 20
Weight per pallet 2,788 lbs.

LARGE UNIT

60 lbs. (27 kg)
6" h x 10" d x 16" / 14" w
(150mm x 250mm x 400mm/350mm)



MEDIUM UNIT

40 lbs. (18 kg)
6" h x 10" d x 12" / 10" w
(150mm x 250mm x 300mm/250mm)



SMALL UNIT

25 lbs. (11 kg)
6" h x 10" d x 6" / 4" w
(150mm x 250mm x 150mm/100mm)



STONEGATE • CAPS & STEPS

CAPS

Cap Unit
(One side textured)
72 lbs.
3" h x 12" d x 24" w

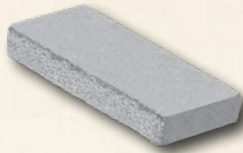

Cap Unit
(Smooth all sides)
72 lbs.
3" h x 12" d x 24" w

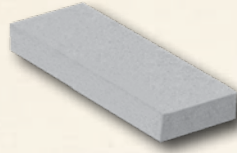

Stocked in all six Standard colors

Stocked in all Stonegate colors and Burgundy Blend

Exposed face area 1/2 sq. ft. (3" x 24")
Units per pallet 48 units
Weight per pallet 3,504 lbs.
Linear foot coverage 2 l.f.

PINS

Stonegate Shouldered Pin
5-1/4" long
1/2" diameter
3/4" diameter at shoulder
100 pins/box
5 pins/set of Stonegate
1 box (100 pins) per pallet of Stonegate



COUNTRY CORNER



The 3" x 12" x 12" Country Corner coping corner unit allows the user to make attractive and simple-to-build 90 degree corners when capping a wall using the 3" x 12" x 24" cap. It has two faces, either textured or smooth to match the 24" caps with one side textured or with all smooth sides. This eliminates the need to make difficult miter cuts and also allows the user to make attractive caps for the 20", 26", 30" and 38" Stonegate piers (See page 83).

Size 3" h x 12" d x 12" w
Exposed face area 1/4 sq. ft. (3" x 12")
Weight 36 lbs.
Units per pallet 96 units
Weight per pallet 3,504 lbs.

Face and Sides Textured

Smooth All Sides



STEP DETAILS

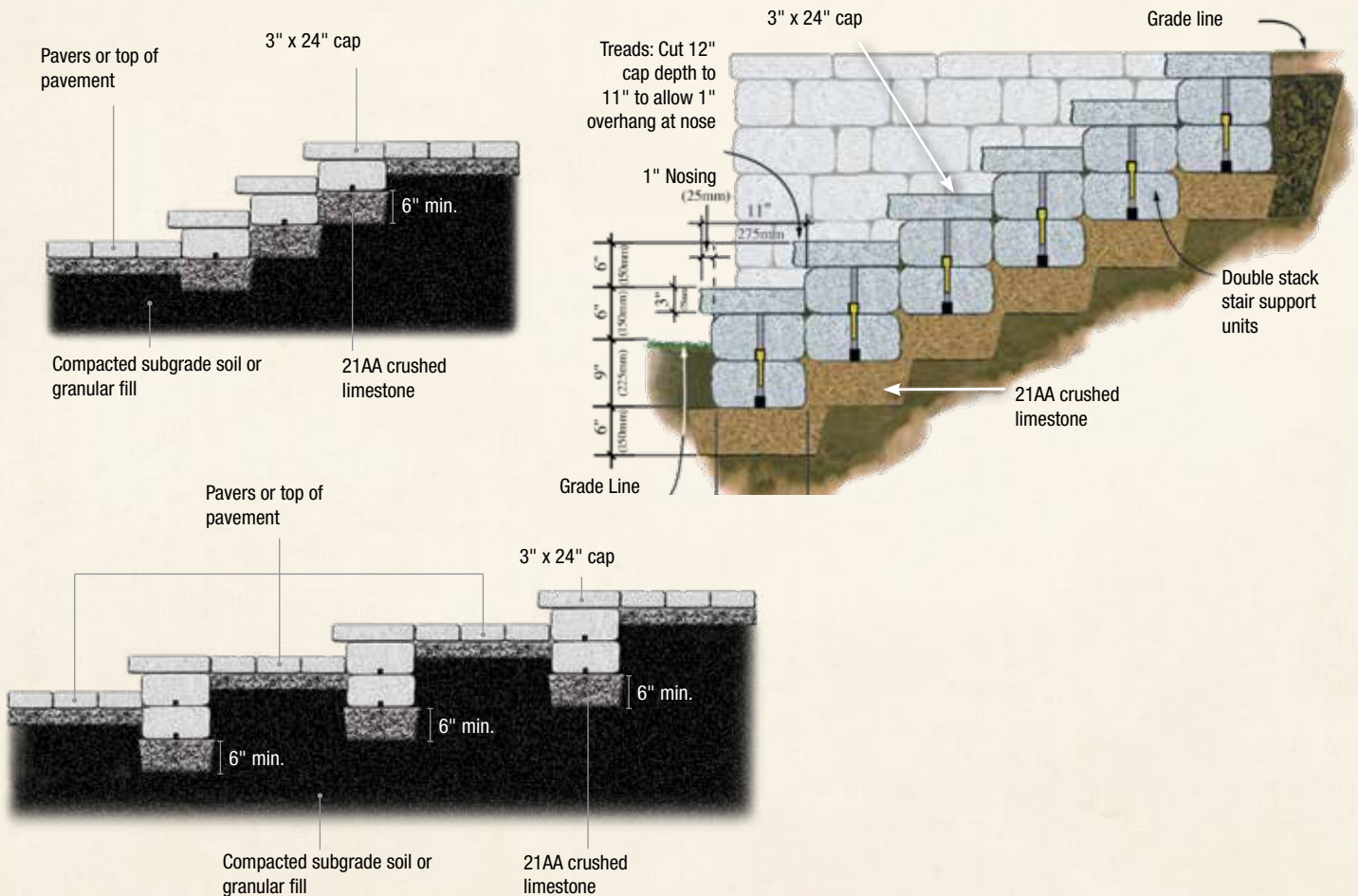

PIER AND PIER CAP DETAILS

20" Pier



20" Pier, 1st and odd numbered courses



20" Pier, 2nd and even numbered courses

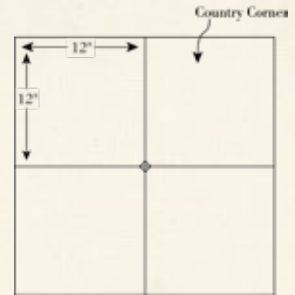

Small Pier Cap: Size: 24" square
For 20" pier or center top cap of larger piers.

26" Pier



26" Pier, 1st and odd numbered courses



26" Pier, 2nd and even numbered courses

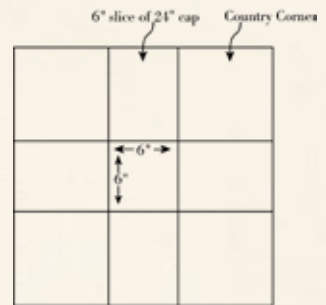

Cap for 26" Pier: Size: 30" square
Note: Leave 6" square in center open for plantings or cover with 24" pier cap.

30" Pier



30" Pier, 1st and odd numbered courses



30" Pier, 2nd and even numbered courses

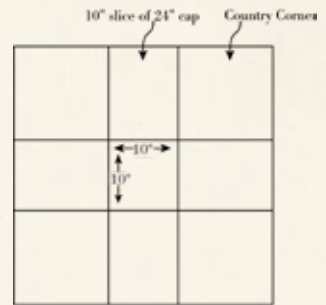

Cap for 30" Pier: Size: 34" square
Note: Leave 10" square in center open for plantings or cover with 24" pier cap.

38" Pier



38" Pier, 1st and odd numbered courses

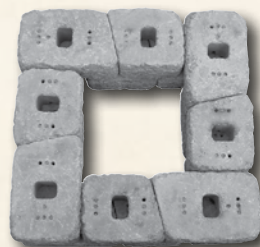

38" Pier, 2nd and even numbered courses

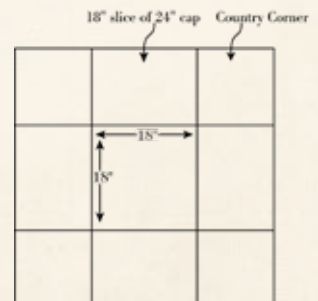

Cap for 38" Pier: Size: 42" square
Note: Leave 18" square in center open for plantings or cover with 24" pier cap. (24" pier cap for center may need to be glued at the joints ahead of time and allowed to set up prior to installation.)

DESIGN DETAILS

FREE-STANDING WALL APPLICATIONS

Column Corner

Similar to the “L” Return End wall detail, the Column Corner utilizes a 20" x 20" column geometry to develop an integrated pier at the end of a running wall. The detail offers visual aesthetic interest as well as provides strength at the termination end of the free-standing wall.

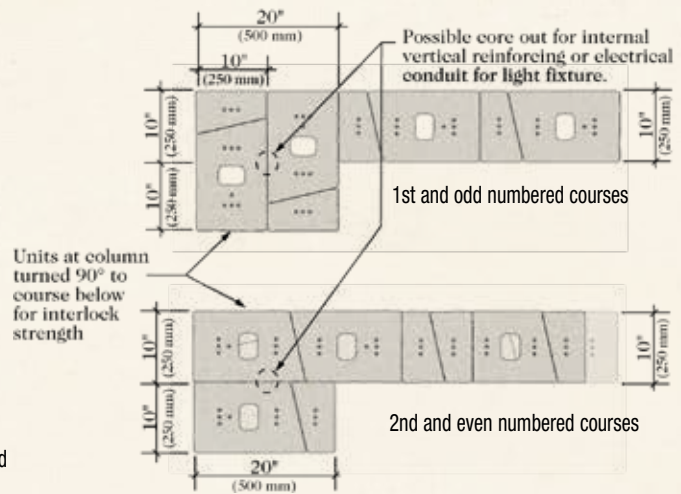
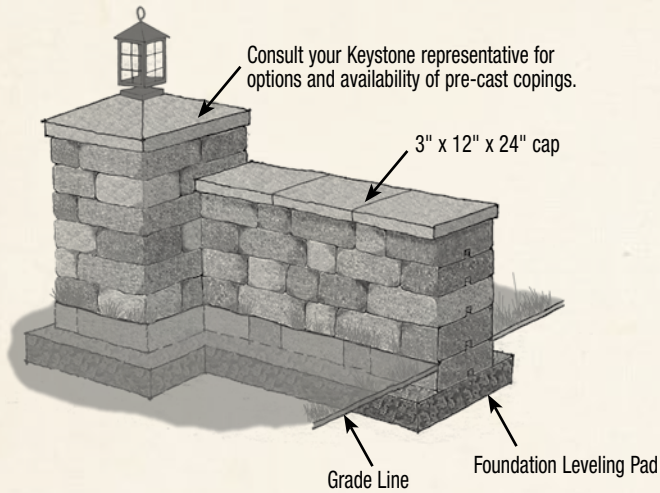

Wall End Column

The Wall End column is a larger version of the “Column Corner” detail. The benefit of this design option is the development of internal reinforcement to provide for greater strength and height, along with a larger footprint dimension for aesthetic purposes.

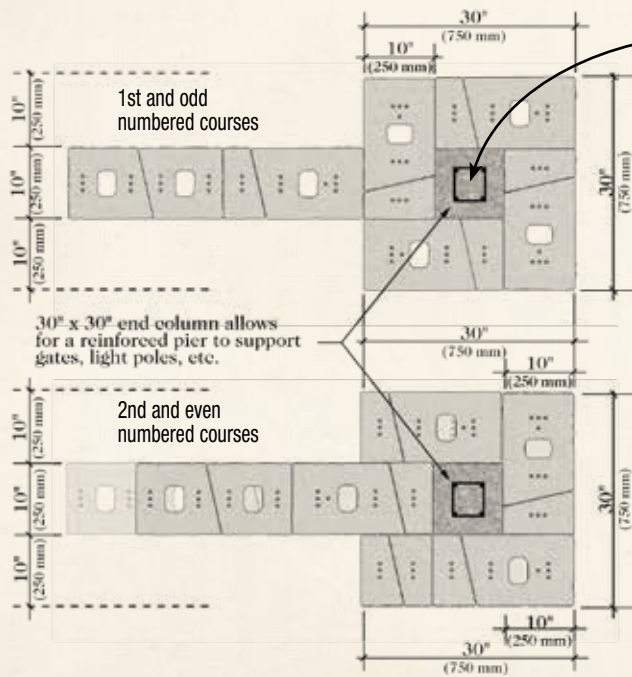

Internal column reinforcing should provide for steel rebar and solid concrete grouting in connection with a reinforced concrete foundation.

Optional capping pattern using Country Corner

Cut caps to fit against perpendicular surface

3" x 12" x 24" cap

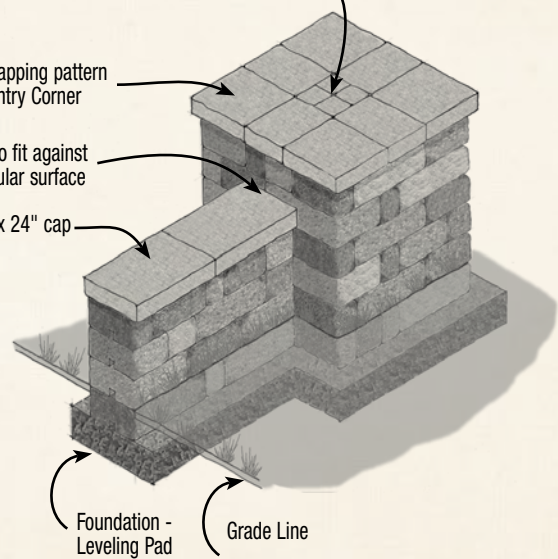

DESIGN CONSIDERATIONS

Gravity Wall – Near Vertical Detail

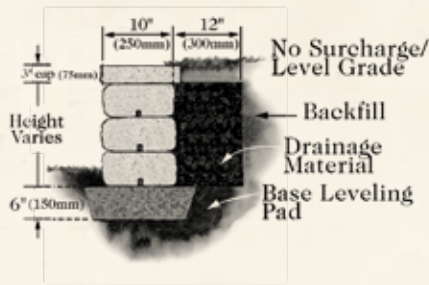

Gravity Wall – Setback Detail 9.5° + Batter

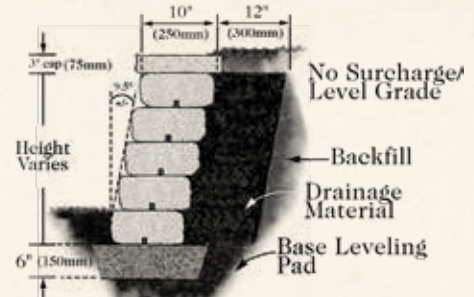

Reinforced Wall – Near Vertical Detail

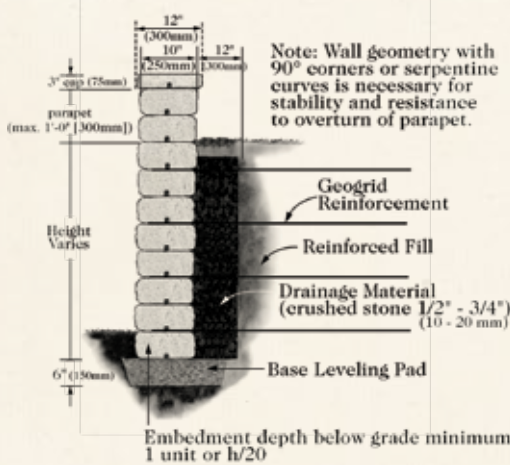

Reinforced Wall – Setback Detail 9.5° + Batter

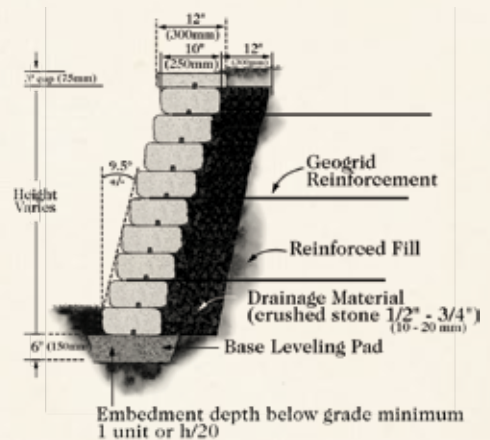

GRAVITY WALLS (maximum unreinforced wall height)				
Maximum Height	Near Vertical		9.5° +/- Batter	
	Level	3H:1V	Level	3H:1V
SAND/GRAVEL PHI = 34°	2'-0" (0.6m)	1'-6" (0.45m)	3'-0" (0.9m)	2'-6" (0.75m)
SILTY SAND PHI = 34°	1'-6" (0.45m)	1'-6" (0.45m)	2'-6" (0.75m)	2'-0" (0.6m)
SILT/LEAN CLAY PHI = 26°	1'-6" (0.45m)	1'-0" (0.3m)	2'-0" (0.6m)	1'-6" (0.45m)

REINFORCED WALLS — Vertical

GEOGRID: Per manufacturer recommendation.

DESIGN NOTES

- Friction angle (PHI) for earth pressure calculations is min. 28° max. 32°
- Moist weight of all soil types is 120 lbs./ft.³ (19kN/m²)
- Sliding calculations use 6" (150mm) crushed stone leveling pad as compacted foundation material
- All backfill materials are compacted to 95% maximum density
- The term "vertical" implies a wall built to a near vertical alignment with a slight positive setback
- The information provided herein is for preliminary design use only. A qualified engineer should be consulted for design and analysis of structures. Keystone Retaining Wall Systems, Inc. assumes no liability for the improper use of these tables

REINFORCED WALLS — Battered (9.5° +/- setback)

GEOGRID: Per manufacturer recommendation.

Stonegate installation and design information reprinted by permission of Keystone Retaining Wall Systems, Inc.

WALL CAPS & STAIR TREADS

Inventoried Colors

12" x 12" COUNTRY CORNER CAP

- Camel
- Chestnut
- Limestone Blend
- Rustic Blend
- Slate
- Walnut Blend
- Whitestone



12" x 12" COUNTRY CORNER CAP



UNIVERSAL CAP

Inventoried Colors

UNIVERSAL CAP

- Camel
- Chestnut
- Desert Brown
- Graphite Blend
- Grey
- Limestone Blend
- Rustic Blend
- Slate
- Walnut Blend

3" x 24" CAP SINGLE FACE SOFT SPLIT

- Camel
- Limestone Blend
- Rustic Blend
- Slate
- Walnut Blend



3" x 24" SINGLE FACE SOFT SPLIT CAP

3" x 24" ALL SMOOTH CAP



3" x 24" CAP ALL SMOOTH

- Camel
- Chestnut
- Limestone Blend
- Rustic Blend
- Slate
- Walnut Blend
- Whitestone

COPING STONE

- Limestone Blend
- Rustic Blend
- Slate
- Walnut Blend



COPING STONE



STAIR TREAD

UNIVERSAL STAIR TREAD

- Limestone Blend
- Walnut Blend

GLENSTONE BULLNOSE

- Walnut Blend
- Limestone Blend
- Slate
- Camel



GLENSTONE BULLNOSE



OLD WORLD GLENSTONE BULLNOSE

OLD WORLD GLENSTONE BULLNOSE

- Walnut Blend
- Limestone Blend
- Slate
- Camel

	12" x 12" Country Corner Cap	Universal Cap	3" x 24" Soft Split Cap	3" x 24" All Smooth Cap	Coping Stone	Stair Tread	Glenstone Bullnose
Size (inches)	3"h x 12"w x 12"d	3-1/2"h x 18"w x 12"d	3"h x 24"w x 12"d	3"h x 24"w x 12"d	2-3/8"h x 3-7/8"w x 12-7/8"d	3-1/2"h x 18"w x 20"d	4"h x 8"w x 12"d
Weight per unit (lbs.)	36	62	70.1	71.5	9.915	106	29.7
Units per pallet	96	56	48	48	117	28	96
Weight per pallet (lbs.)	3,456	3,472	3,365	3,432	1,160	2,968	2,858

Miter Cutting Universal Cap Units to Cap Inside and Outside 90° Corners

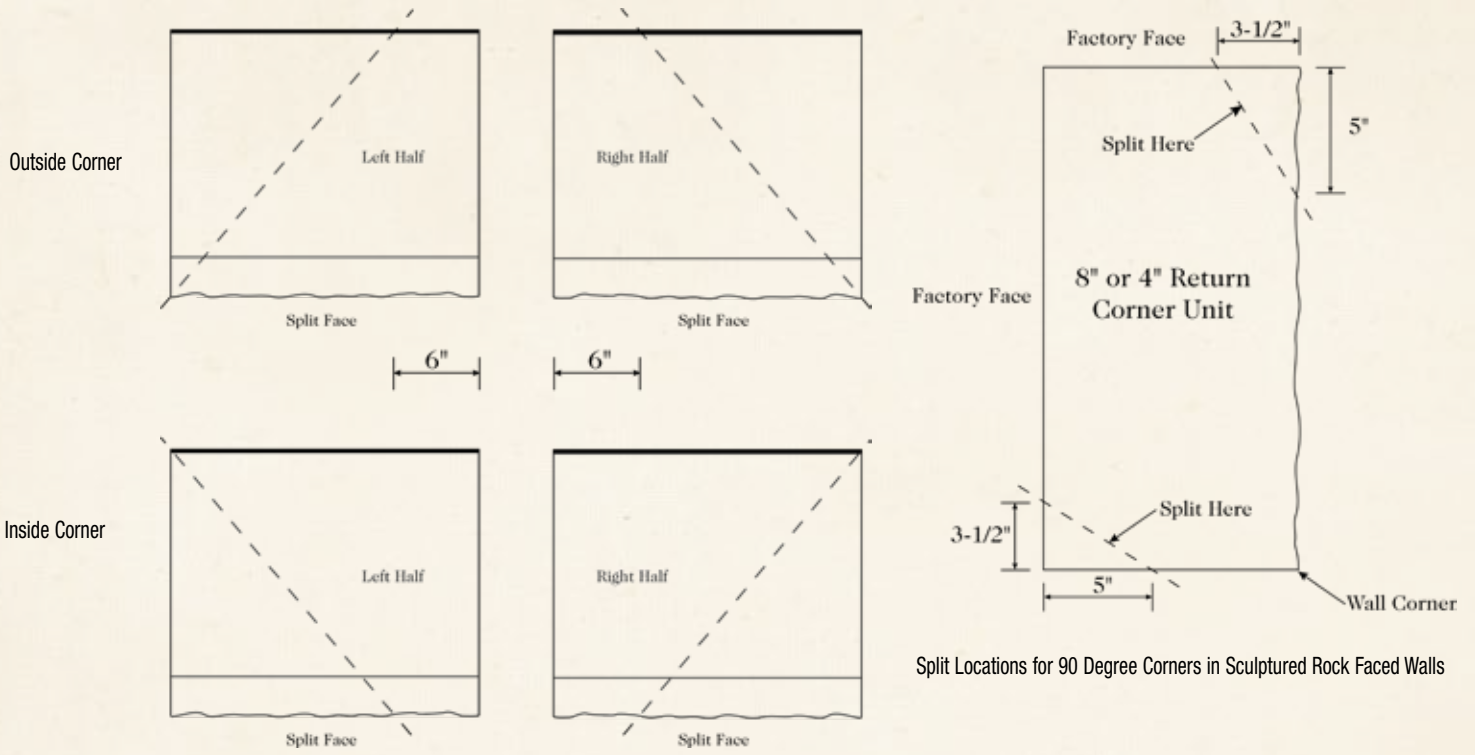

STEP OPTIONS:

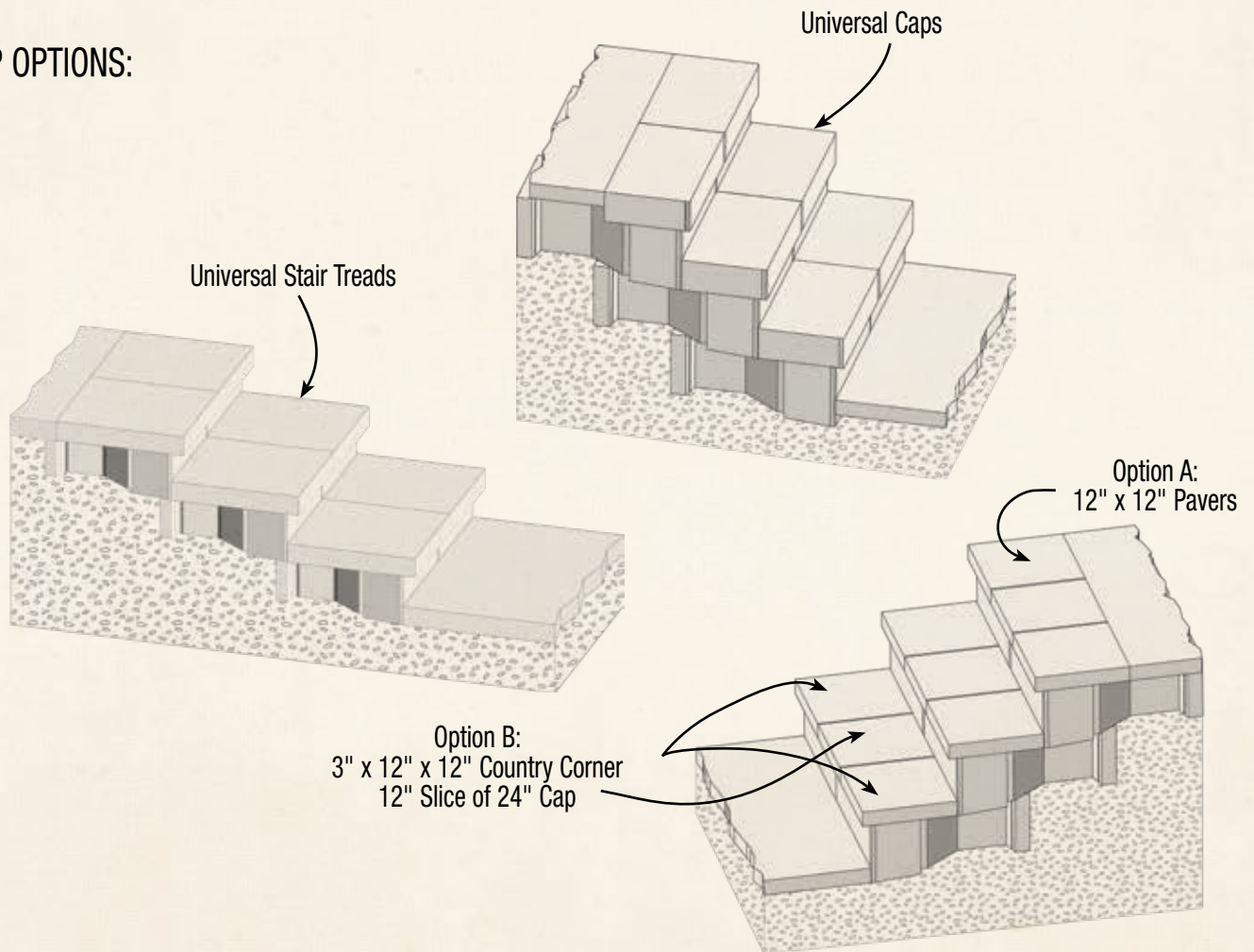

COPING STONE

➤ POOL COPING: COPING STONE – WALNUT BLEND
PAVERS: OLD WORLD VINTAGE – SEASHELL



OLD WORLD GLENSTONE BULLNOSE

STEP COPING: OLD WORLD GLENSTONE BULLNOSE – CAMEL
PAVERS: HARBOR STONE – IRONWOOD
ACCENT PAVERS: OLD WORLD VINTAGE XLR – COFFEE & SUMMER WHEAT
WALLS: OLD WORLD STONEGATE – CAMEL
WALL ACCENT COURSE: OLD WORLD VINTAGE XLR – COFFEE



STANDARD COLORS



O.W. WALNUT BLEND



O.W. CAMEL



O.W. SLATE



O.W. LIMESTONE BLEND

FIRE PIT BLOCK

> FIRE PIT: FIRE PIT BLOCK – SLATE
FIRE PIT CAP: PRECAST UNIT
SEAT WALL: STONEGATE – SLATE
SEAT WALL CAPS: PRECAST UNIT
WALLS: STONEGATE – SLATE
WALL CAPS: 3x24 SMOOTH CAP – LIMESTONE BLEND



OLD WORLD FIRE PIT BLOCK

> FIRE PIT: OLD WORLD FIRE PIT BLOCK – LIMESTONE BLEND
 FIRE PIT CAP: OLD WORLD 4" RADIUS GLENSTONE – LIMESTONE BLEND
 WALLS: OLD WORLD STONEGATE – LIMESTONE BLEND
 WALL ACCENT COURSE: OLD WORLD VINTAGE XLR – BURGUNDY BLEND
 PAVERS: OLD WORLD VINTAGE – LIMESTONE BLEND
 ACCENT PAVERS: OLD WORLD VINTAGE XLR – BURGUNDY BLEND



The installation of an optional metal ring may extend the life of the Fire Pit blocks.

Old World Fire Pit Block



Size: 5-1/2"h x 6"d x 15-1/2"/12-1/2"w

- Makes perfect 4' diameter circle (I.D.)
- No cutting required – 12 units per circle
- Also ideal for tree rings, wishing wells, etc.
- Stock colors: Walnut, Limestone, Slate
- 75 Units/pallet
- 38.8 lbs./unit
- 2,910 lbs./pallet

STANDARD COLORS



O.W. WALNUT BLEND



O.W. LIMESTONE BLEND



O.W. SLATE

Old World 4" Radius Glenstone



Size: 4"h x 8"d x 12-1/4"/9-1/8"w

- Great as a cap for Fire Pit Block
- Use with our Glenstone wall to turn radius
- No cutting required – 16 units per circle
- Stock colors: Walnut, Rustic, Limestone, Slate
- 96 Units/pallet
- 27.55 lbs./unit
- 2,645 lbs./pallet

KEYSTONE HEWNSTONE

› TOP:
WALLS: COMPAC HEWNSTONE – CAMEL
CAPS: 3x24 CAP – WALNUT BLEND

› BOTTOM:
WALLS: COMPAC HEWNSTONE – CAMEL
CAPS: UNIVERSAL CAP – CAMEL
PAVERS: HOLLAND SERIES – WALNUT BLEND



WALLS: COMPAC HEWNSTONE – WALNUT BLEND
CAPS & STEP COPING: 3x24 CAP – WALNUT BLEND
PAVERS: OLD WORLD VINTAGE – WALNUT BLEND
ACCENT PAVERS: OLD WORLD VINTAGE XLR – SUMMER WHEAT



KEYSTONE HEWNSTONE

WALLS: COMPAC HEWNSTONE – WALNUT BLEND
WALL CAP: 3x24 SMOOTH CAP – WALNUT BLEND



- > TOP:
WALLS: COMPAC HEWNSTONE – WALNUT BLEND
CAPS: 3x24 CAP – WALNUT BLEND
- > BOTTOM:
PIER: COMPAC HEWNSTONE 90-DEGREE RETURN CORNER – SLATE



8" x 18" x 9" Hewnstone Return Corner



KEYSTONE COMPAC HEWNSTONE UNIT:

Size	8"h x 18"w x 11"d
Exposed face area	1 sq. ft. (8" x 18")
Weight	86 lbs.
Units per pallet	36 units
Weight per pallet.....	3,096 lbs.

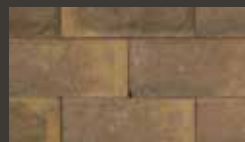

WALNUT BLEND



LIMESTONE BLEND



CAMEL



SLATE

KEYSTONE STRAIGHT SPLIT

➤ WALLS: 4" MINI KEYSTONE STRAIGHT SPLIT – DESERT BROWN (SPECIAL ORDER)

Keystone Straight Split wall stones are clean cut and classic for those seeking a more traditional wall presentation. Keystone Straight Split wall stones are available in a wide variety of sizes and colors. Imagine the creative possibilities! Perfect for border walls, tree rings, terraces, corners, curves, steps and stairs.



➤ ABOVE:
WALLS: 8" KEYSTONE STRAIGHT SPLIT – CUSTOM COLOR

4" MINI STRAIGHT SPLIT

➤ 4" MINI STRAIGHT SPLIT – SPECIAL ORDER ONLY



Size 4" h x 18" w x 11" d
Exposed face area 1/2 sq. ft. (4" x 18")
Weight 43 lbs.
Units per pallet 63 units
Weight per pallet 2,709 lbs.

8" COMPAC III STRAIGHT SPLIT



Size 8" h x 18" w x 11" d
Exposed face area 1 sq. ft. (8" x 18")
Weight 79 lbs.
Units per pallet 36 units
Weight per pallet 2,844 lbs.

8" STANDARD STRAIGHT SPLIT



Size 8" h x 18" w x 22" d
Exposed face area 1 sq. ft. (8" x 18")
Weight 128 lbs.
Units per pallet 20 units
Weight per pallet 2,560 lbs.

FIBERGLASS PIN



5-1/4" long
1/2" diameter
100 pins/box
Two pins needed for each
Mini, Compac and Standard



STANDARD COLORS

COMPAC UNITS



GRAY



RUSTIC BLEND

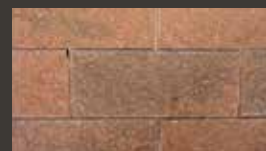

DESERT BROWN

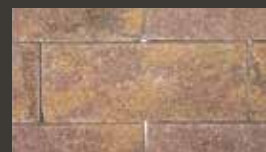

WALNUT BLEND



LIMESTONE BLEND

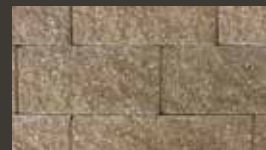

CAMEL

ELITE COLORS



GRAPHITE BLEND

> UPPER WALL: VERAZZO – WALNUT BLEND
 UPPER WALL CAP: 3x24 – CAMEL
 LOWER WALL: COMPAC STRAIGHT SPLIT – WALNUT BLEND
 LOWER WALL CAP: UNIVERSAL CAP – WALNUT BLEND

90 DEGREE RETURN CORNER UNITS

4" 90° CORNER

> 4" 90° CORNER – SPECIAL ORDER ONLY



Size 4" h x 18" w x 9" d
 Exposed face area 1/2 sq. ft. (4" x 18")
 Weight 43 lbs.
 Units per pallet 60 units
 Weight per pallet 2,580 lbs.

8" 90° CORNER



Size 8" h x 18" w x 9" d
 Exposed face area 1 sq. ft. (8" x 18")
 Weight 86 lbs.
 Units per pallet 30 units
 Weight per pallet 2,580 lbs.

KEYSTONE SCULPTURED SPLIT

➤ NEXT PAGE TOP:
8" KEYSTONE SCULPTURED SPLIT – RUSTIC BLEND
(NON-INVENTORIED COLOR)

➤ NEXT PAGE BOTTOM:
8" KEYSTONE SCULPTURED SPLIT – GRAY

Like Keystone Straight Split, Keystone Sculptured Split wall stones offer a traditional and classic presentation. But you can add a creative flair with Keystone Sculptured Split wall stones. Available in a variety of colors and sculpted faces, these wall stones offer unlimited design possibilities. Turn any landscaping project — large or small — into a work of art!



➤ RIGHT:
8" KEYSTONE SCULPTURED FACE – DESERT BROWN

➤ BELOW:
8" KEYSTONE SCULPTURED SPLIT – DESERT BROWN



8" COMPAC SCULPTURED SPLIT



Size 8" h x 18" w x 11" d
Exposed face area 1 sq. ft. (8" x 18")
Weight 86 lbs.
Units per pallet 36 units
Weight per pallet 3,096 lbs.

8" STANDARD SCULPTURED SPLIT



Size 8" h x 18" w x 22" d
Exposed face area 1 sq. ft. (8" x 18")
Weight 128 lbs.
Units per pallet 20 units
Weight per pallet 2,560 lbs.

8" 90° CORNER



Size 8" h x 18" w x 9" d
Exposed face area 1 sq. ft. (8" x 18")
Weight 86 lbs.
Units per pallet 30 units
Weight per pallet 2,580 lbs.

FIBERGLASS PIN



5-1/4" long
1/2" diameter
100 pins/box
Two pins needed for each
Mini, Compac and Standard

(See splitting detail on page 87)

COMPAC COLOR



DESERT BROWN



CURVES AND CORNERS

CONCAVE CURVES INSTALLATION PROCEDURES:

1. Follow standard installation instructions for preparation of the subgrade and the leveling pad.
2. Overlap the corners of the base course. The amount of overlap will vary based on the size of the curve. Gapping will occur as the units batter or move away from the point of radius. The rate of gapping is controlled by the severity of the batter (i.e., a 1:8 batter will gap more quickly than a 1:128 batter). The distance between the pin holes of adjacent first course units should not exceed 12" on center. For best visual appearance, a maximum 1/2" to 3/4" gap is recommended.
3. Follow standard installation instructions for backfilling and placement of additional courses.
4. If geogrid reinforcement is used, refer to manufacturer's recommendations for proper placement of this material along concave curves and corners.
5. Depending on wall height, radius and batter selection, some gapping between units may occur. If gaps exceed acceptable limits, redrill new pin holes as needed, using a 5/8" masonry bit, and realign units to close the gaps.

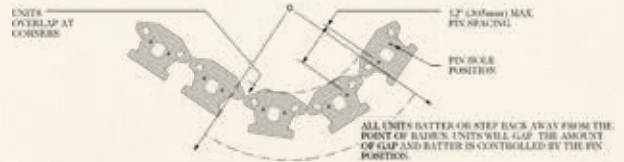
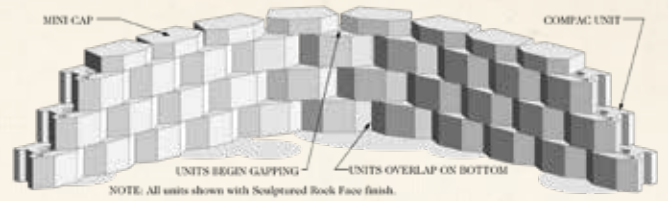

CONVEX CURVES INSTALLATION PROCEDURES

1. Follow standard installation instructions for preparation of subgrade and leveling pad.
2. Place base course units with a small gap between adjacent units. This gap will close with the placement of each additional course of Keystone units as the units batter and converge toward the point of radius. The rate of closure is controlled by the severity of the batter (i.e., a 1:8 batter will close more quickly than a 1:128 batter). A maximum of 1/2"-3/4" gap is recommended for best visual appearance. To achieve this, the distance between the pin holes on adjacent first course units should not exceed 12" on center.
3. Follow standard installation instructions for backfilling and placement of additional courses.
4. If geogrid reinforcement is used, refer to manufacturer's recommendations for proper placement of this material along convex curves.
5. Depending on wall height, radius and batter selection, some binding between units may occur. If this prohibits proper placement of additional units, try one of the following suggestions:
 - Trim unit corners using either a masonry chisel or concrete saw.
 - Push units back and realign. Redrill pin holes as needed using a 5/8" masonry bit.

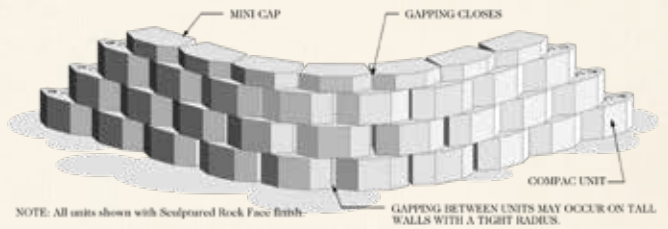

90° OUTSIDE CORNER

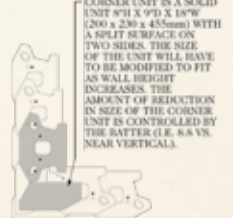
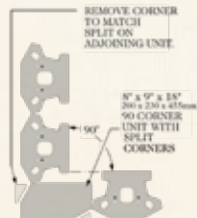
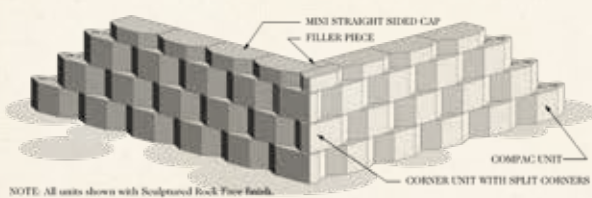

90° INSIDE CORNER - ROUNDED

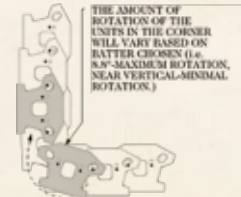
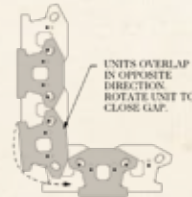
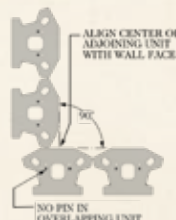
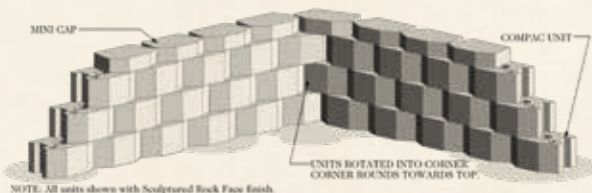

GRAVITY WALL DESIGN CHARTS

NEAR VERTICAL WALL

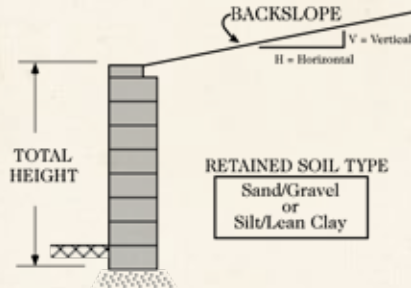

ONE INCH SETBACK WALL

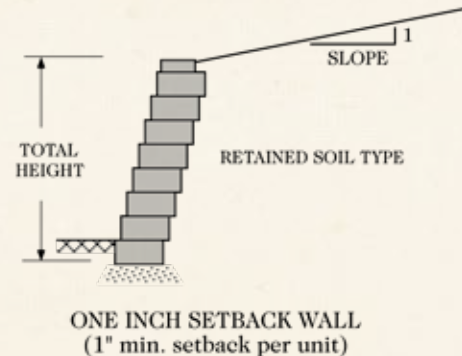

STANDARD UNITS

MAXIMUM GRAVITY WALL HEIGHT CHART				
Near Vertical Wall	Backslope			
	Level	4H:1V	3H:1V	2H:1V
Soil Type	Level	4H:1V	3H:1V	2H:1V
Sand/Gravel	5.2' (1.6m)	4.7' (1.5m)	4.6' (1.4m)	4.1' (1.2m)
Silty Sand	4.7' (1.4m)	4.3' (1.3m)	4.1' (1.2m)	3.6' (1.1m)
Silt/Lean Clay	4.4' (1.3m)	3.9' (1.2m)	3.7' (1.1m)	2.9' (0.9m)

COMPAC UNITS

MAXIMUM GRAVITY WALL HEIGHT CHART				
Near Vertical Wall	Backslope			
	Level	4H:1V	3H:1V	2H:1V
Soil Type	Level	4H:1V	3H:1V	2H:1V
Sand/Gravel	2.9' (0.9m)	2.3' (0.71m)	2.3' (0.71m)	2.3' (0.71m)
Silty Sand	2.3' (0.71m)	2.3' (0.71m)	1.7' (0.51m)	1.7' (0.51m)
Silt/Lean Clay	2.3' (0.71m)	1.7' (0.51m)	1.7' (0.51m)	1.0' (0.30m)

STANDARD UNITS

MAXIMUM GRAVITY WALL HEIGHT CHART				
Near Vertical Wall	Backslope			
	Level	4H:1V	3H:1V	2H:1V
Soil Type	Level	4H:1V	3H:1V	2H:1V
Sand/Gravel	6.8' (2.1m)	6.2' (1.9m)	5.9' (1.8m)	5.3' (1.6m)
Silty Sand	6.1' (1.9m)	5.5' (1.7m)	5.2' (1.6m)	4.4' (1.3m)
Silt/Lean Clay	5.3' (1.6m)	4.5' (1.4m)	4.1' (1.2m)	3.2' (1.0m)

COMPAC UNITS (1" SETBACK OPTION AVAILABLE IN STRAIGHT FACE AND HEWNSTONE UNITS ONLY)

MAXIMUM GRAVITY WALL HEIGHT CHART				
Near Vertical Wall	Backslope			
	Level	4H:1V	3H:1V	2H:1V
Soil Type	Level	4H:1V	3H:1V	2H:1V
Sand/Gravel	3.67' (1.20m)	3.67' (1.20m)	3.00' (0.91m)	3.00' (0.91m)
Silty Sand	3.00' (0.91m)	3.00' (0.91m)	3.00' (0.91m)	2.33' (0.71m)
Silt/Lean Clay	3.00' (0.91m)	2.33' (0.71m)	2.33' (0.71m)	<1.00' (0.30m)

GEOGRID CHART NOTES

The Keystone geogrid charts are graphically presented to show the proper orientation and lengths of geogrids used with Standard and Compac Units at the near vertical batter.

Heights were set in two-block increments beginning at 4.3' and ending at 11'. Engineering judgement should be used when interpolating between heights. Heights under the 4.3' height shown may require geogrid reinforcement depending upon the units used, soil types and surcharge loadings.

Soil ranges were selected to approximate good, medium and poor soil conditions to concisely cover the typical design range. Wall height is the total height of the wall from leveling pad to the top of the wall. The charts assume the use of a lower strength geogrid, and can be used safely with the following materials:

- Synteen SF35
- Stratagrid 200 by Strata Systems
- Mirafi 3XT

All geogrid lengths shown are the actual lengths of geogrids required as measured from the connection points to the end of the geogrid.

The design charts assume that the walls are constructed in accordance with Keystone specifications and good construction practice. All soils must be compacted in 8" lifts to 95% Standard Proctor density as determined by laboratory testing.

The information contained in the design charts is for preliminary design use only. A qualified professional should be consulted for final design assistance. Keystone accepts no liability for the improper use of these charts.

DESIGN CHARTS FOR KEYSTONE STANDARD

KEYSTONE STANDARD UNIT REINFORCEMENT DESIGN CHARTS

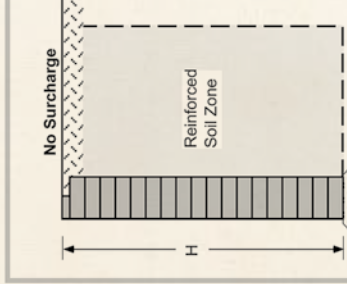

CASE 1

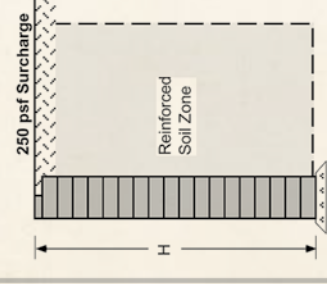

CASE 2

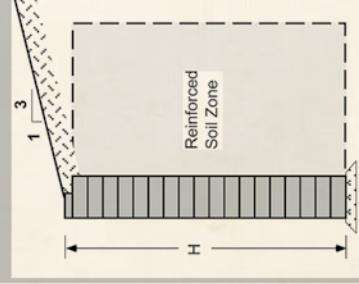

CASE 3

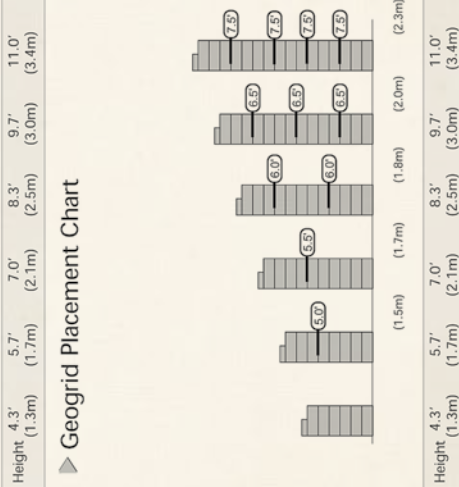
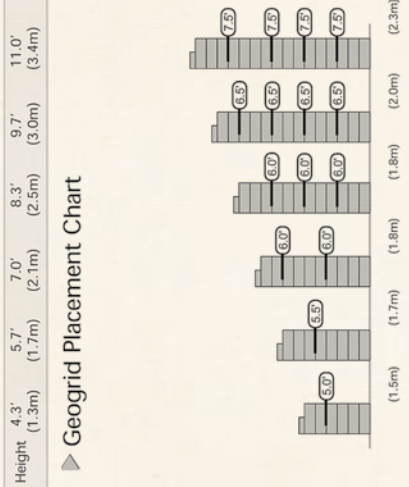
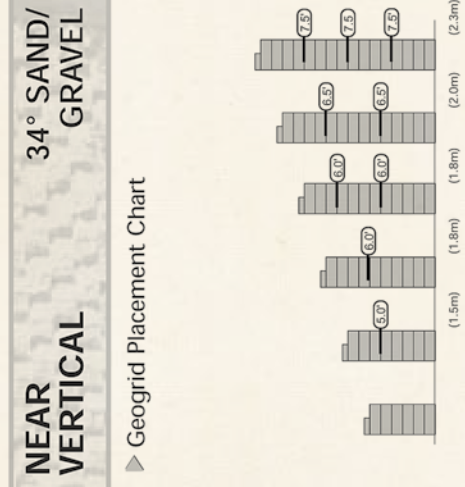
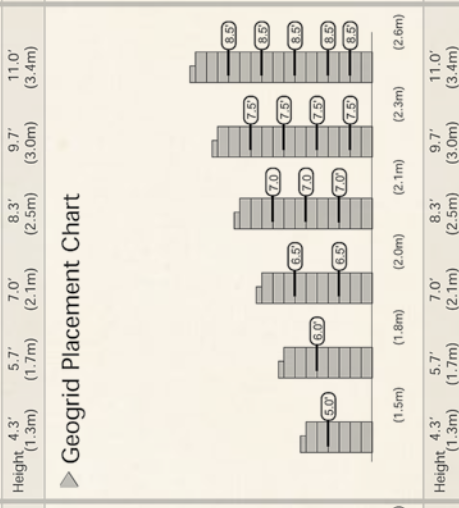
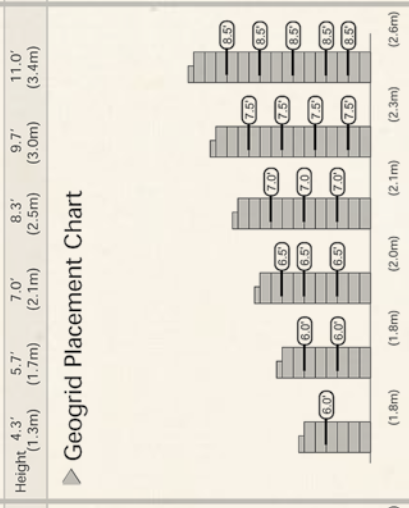
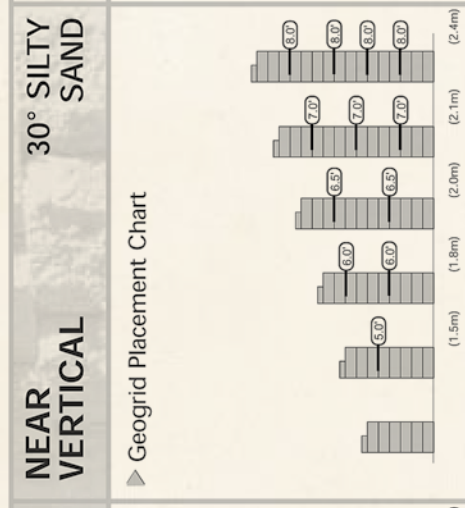
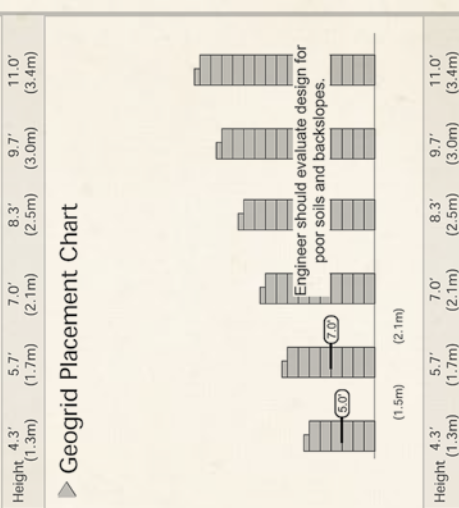
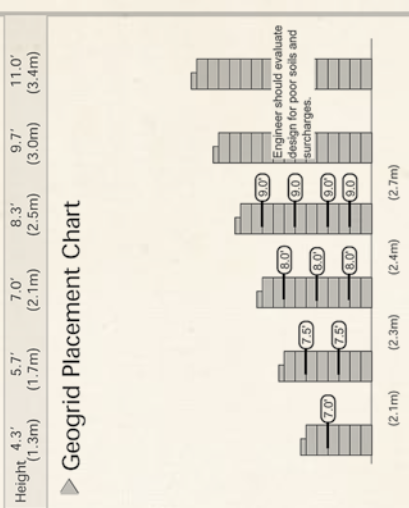
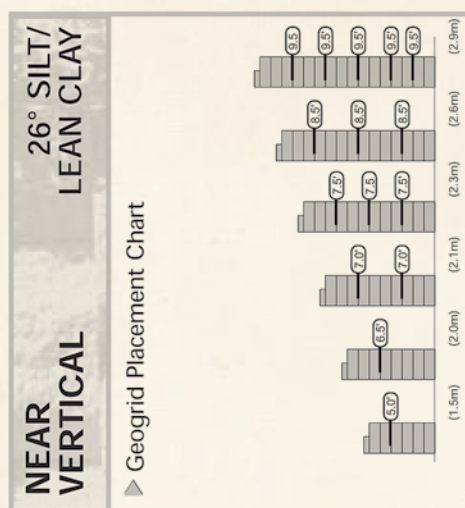

DESIGN CHARTS FOR KEYSTONE COMPAC

KEYSTONE COMPAC UNIT REINFORCEMENT DESIGN CHARTS

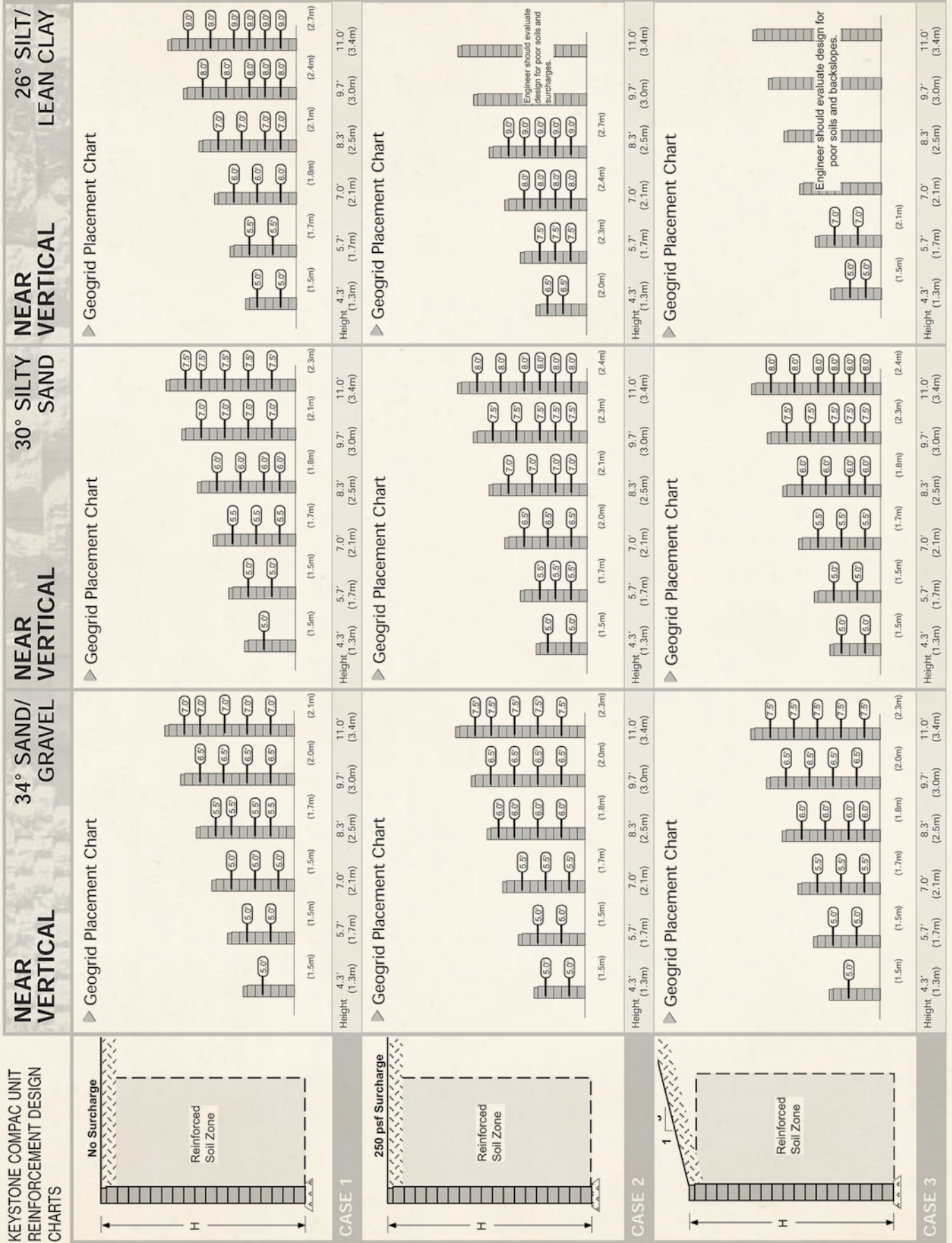

BASIC PRODUCT INSTALLATION



Retaining Excellence™

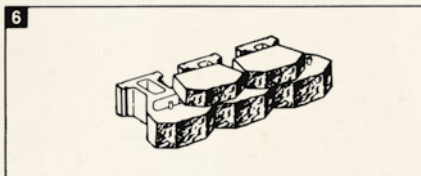
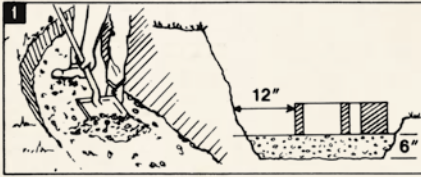

The Keystone Retaining Wall System was developed with simplicity of construction in mind. The following steps will guide you from start to finish.

■ STEP 1: PREPARATION OF BASE LEVELING PAD

Excavate a shallow trench to the designed length and width dimensions for your Keystone wall. Provide 12" behind the Keystone unit to allow for a granular backfill drainage zone. Keystone units should be placed on a 6" leveling pad of compacted well draining fill (i.e., sand, 1/2" to 3/4" crushed stone or gravel) at 95% Standard Proctor compaction or equal. Provide additional trench depth for below grade placement of Keystone units on a ratio of 1" below grade for each 8" of wall height above grade.

NOTE: When constructing walls less than 3' high, Keystone units can be placed on firm, undisturbed, inorganic soils. Recommended 12" drainage zone may vary due to site, soil or engineering requirements.

■ STEP 2: INSTALLING THE BASE COURSE

Install the first course of Keystone units side by side over the prepared base. Level each unit side to side and front to back. Place the units such that the kidney-shaped void is on the bottom surface. Line up pins or back edge of the unit for straight wall alignment. Units should touch side point to side point as diagrammed.

■ STEP 3: INSTALLING THE INTERLOCKING PINS

Place the reinforced fiberglass pins into the paired holes in each Keystone unit. Provide pins of correct length for appropriate unit size. Once in place, the pins will allow an automatic setback when installing additional courses as per STEP 5.

■ STEP 4: INSTALLING BACKFILL AND COMPACTION

Fill all voids in and between Keystone units and behind units 12". This fill should consist of 1/2" to 3/4" crushed stone or clean, well-draining granular fill. This allows for water drainage and compacts easily. Compact to eliminate potential settlement. Backfill behind gravel drainage zone using existing soils. (NOTE: Heavy clays or organic soils are not recommended due to water holding properties.) Compact to 95% Standard Proctor. Backfill in 8" lifts on a course basis.

NOTE: Only lightweight walk-behind mechanical compaction equipment should sweep the units to remove small pebbles, debris, etc., so the units rest evenly upon one another. Backfill and compact at every 8" course.

■ STEP 5: INSTALLING ADDITIONAL COURSES

Place the next course of Keystone units over the positioned fiberglass pins so they are centered on and will bridge two units below in a running bond pattern. Pins should fit into kidney-shaped recesses on bottom of units. Pull the Keystone module toward the face of the wall until the module makes full contact with both pins. Repeat STEPS 3, 4, and 5.

■ STEP 6: INSTALLING KEYSTONE CAPS

Use Keystone cap units to complete your wall. Place the Keystone cap over the projecting pins on the unit below. Pull forward to the automatic set back position. Backfill and compact to finish grade. **NOTE:** In areas of high public accessibility and vandalism, we recommend construction adhesive or epoxy cement be used around the perimeter underside of the cap prior to unit placement.

The above installation guidelines apply to all Keystone unit sizes. These installation procedures do not take into account geological variations in site and soil conditions and, therefore, may require engineering consideration and detail. The final design and construction of a wall is the responsibility of the owner, not Fendt Builder's Supply, Inc., or Keystone Wall Systems, Inc.

GEOGRID INSTALLATION (PATENTED PROCEDURES)

For taller, more critical walls where geogrid is required to resist greater lateral earth pressures, use the following steps for installation:

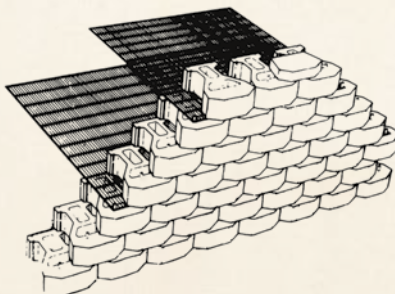

STEP 1: Follow steps 1 through 4 of BASIC PRODUCT INSTALLATION.

STEP 2: Excavate the reinforced soil area to the maximum embedment length.

STEP 3: Cut sections of geogrid off roll to the specified length. Place geogrid in proper orientation (i.e., roll out from wall toward embankment). Check manufacturer's criteria for biaxial or uniaxial geogrids.

STEP 4: Hook geogrid over Keystone fiberglass pins, assuring a secure connection between unit and geogrid.

STEP 5: To pretension geogrid, pull the pinned geogrid taut to eliminate loose folds. Stake or secure back edge of the geogrid prior to and during backfill and compaction.

STEP 6: Install the next course of Keystone retaining wall units.

STEP 7: Proceed to place compacted backfill over geogrid in 8" lifts. Provide minimum 6" soil coverage prior to driving equipment over grid. Avoid tracked or wheeled vehicles directly on grid, or turning on grid.

STEP 8: Continue steps 3 through 7 until the retaining wall is complete.

FENDT LANDSCAPE WALL COLORS

Fendt offers a wide variety of colors and geometric shapes to meet your specific requirements. Don't see what you need? Fendt can custom manufacture any of the shapes shown, in any color your imagination desires. Your Fendt representative can also discuss Fendt's custom color and texture matching technology. Just bring us a brick or a portion of an existing retaining wall and we'll match the color and texture to add the perfect personalized finishing touch to any commercial or residential job.

GARDEN WALL COLORS



ANTIQUE BLEND



WALNUT BLEND



GOLDENROD



RUSTIC BLEND



DESERT BROWN



LIMESTONE BLEND



RED



SLATE



GRAY

VERAZZO COLORS



WALNUT BLEND



RUSTIC BLEND



LIMESTONE BLEND



SLATE



CAMEL

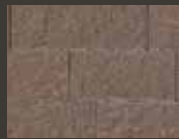

CHESTNUT



GRAPHITE (ELITE)

STONEGATE & OLD WORLD STONEGATE COLORS



WALNUT BLEND



RUSTIC BLEND



LIMESTONE BLEND



CAMEL



SLATE



GRAPHITE

KEYSTONE STANDARD, COMPAC & MINI COLORS



GRAY

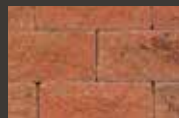

RUSTIC BLEND

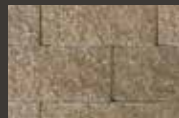

CAMEL

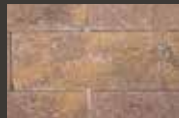

WALNUT BLEND



LIMESTONE BLEND

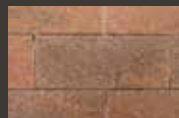

DESERT BROWN

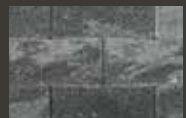

GRAPHITE

GLENSTONE COLORS

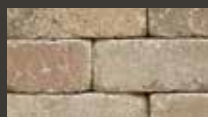

WALNUT BLEND



RUSTIC BLEND



BURGUNDY BLEND



SLATE



GRAYLING



IRONWOOD



LIMESTONE BLEND



CAMEL



GREYSTONE



CHESTNUT



STERLING SMOKE



ALABASTER

PAVER & WALL STONE REFERENCE GUIDE

INVENTORIED PAVERS	Description	Units Per Sq. Ft.	Sq. Ft. Per Cube	Units Per Cube	Weight Per Sq. Ft.	Weight Per Cube	Sq. Ft. Per Strap
Holland 4" x 8"	2-3/8" Thick	4.5	108	486	28	3,024	18
Holland 8" x 8"	2-3/8" Thick	2.25	96	216	28	2,688	16
Holland 12" x 12"	2-3/8" Thick	1	72	72	28	2,016	18
Harbor Stone & Bay Stone							
Mega Large Rectangle	9-1/2" x 14-1/4" x 2-3/8"	1.06	90	96	28	2,688	30
Large Square	9-1/2" x 9-1/2" x 2-3/8"	1.6	97	160	28	2,716	19.4
Extra Large Rectangle	9-1/2" x 4-3/4" x 2-3/8"	3.1	90	280	28	2,509	17.92
Symetry®	2-3/8" Thick	3.4	84	288	28	2,352	21
6" x 6" (Use With Symetry)	2-3/8" Thick	4.1	92	378	28	2,576	13.14
Vintage Series - Circle Cube							
Square	4-3/4" x 4-3/4" x 2-3/8"	6.3	8.85	56	28	—	—
Large Circle	4-11/16" x 4-5/16" x 2-3/8"	8.3	14.45	120	28	—	—
Small Circle	4-11/16" x 4-5/16" x 2-3/8"	8.7	1.8	16	28	—	—
Half Stone	4-3/4" x 3-5/8" x 2-3/8"	8.4	10.0	84	28	—	—
Center Stone	4-3/4" x 3-5/8" x 2-3/8"	9	0.4	4	28	—	—
Totals For Cube			35.5	280		994	
Vintage Series - Square & Small Rectangle Cube							
Square	4-3/4" x 4-3/4" x 2-3/8"	6.3	68.6	432	28	—	—
Small Rectangle	4-3/4" x 2-7/16" x 2-3/8"	12.6	11.4	144	28	—	—
Totals For Cube			80	576		2,240	
Vintage Large Rectangle Cube	7-1/8" x 4-3/4" x 2-3/8"	4.2	80	336	28	—	13.33
Old World Holland	2-3/8" Thick	4.5	108	486	28	3,024	—
Old World Vintage	2-3/8" Thick	—	80 (Square Cube)	504	28	2,240	—
	2-3/8" Thick	—	80 (Lg. Rectangle Cube)	336	28	2,240	—
	2-3/8" Thick	—	90 (XL Rectangle Cube)	280	28	2,509	—
	2-3/8" Thick	—	91 (DL Rectangle Cube)	200	28	2,548	—
	2-3/8" Thick	—	97 (Lg. Square Cube)	160	28	2,716	—
Old World Vintage Circle	2-3/8" Thick	—	35.5 (Crate)	—	28	994	—
SPECIAL ORDER PAVERS							
Arrowhead™	2-3/8" Thick	4.8	78.75	378	28	2,205	11.25
Euro Stone (Use With Arrowhead)	2-3/8" Thick	3.7	102	378	28	2,856	14.57
Carousel Series - Circle Cube							
Square	4-1/2" x 4-1/2" x 2-3/4"	7.11	27.84	198	33	—	—
Small Rectangle	4-1/2" x 2-1/4" x 2-3/4"	14.12	.84	12	33	—	—
Large Circle	4-1/2" x 4-1/2" x 2-3/4"	8.3	23.10	192	33	—	—
Small Circle	3-3/8" x 4-1/2" x 2-3/4"	11.43	1.56	18	33	—	—
Totals For Cube			53.34	420		1,760	—
Carousel Series - Square & Small Rectangle Cube							
Square	4-1/2" x 4-1/2" x 2-3/4"	7.11	53.16	378	33	—	—
Small Rectangle	4-1/2" x 2-1/4" x 2-3/4"	14.12	3.84	54	33	—	—
Totals For Cube			57			1,881	
Carousel Series - Large Rectangle Cube							
Large Rectangle	4-1/2" x 6-3/4" x 2-3/4"	4.8	80	384	33		13.33
Cobblestone	2-3/8" Thick	3.5	103	360	28	2,884	20.6
Holland 4" x 4"	2-3/8" Thick	4.5	108	486	28	3,024	18
Holland 8" x 8"	3-1/8" Thick	2.25	74.67	168	37	2,763	—
Holland 4" x 8"	3-1/8" Thick	4.5	84	378	37	3,108	16
Old World Holland 8" x 8"	3-1/8" Thick	2.25	74.67	168	37	2,763	—
Old World Holland 4" x 8"	3-1/8" Thick	4.5	84	378	37	3,108	—
Old World Arrowhead	2-3/8" Thick	4.8	78.75	376	28	2,205	—
Old World Random	2-3/8" Thick	—	96	288	28	2,407	—
Old Style Symetry (Use In Combination With Euro Stone)	2-3/8" Thick	3.1	93	288	28	2,604	23.25
ENVIRONMENTAL PRODUCTS							
Eco-Brick	3-1/8" Thick	3.68	76.3	—	—	2,592	—
Eco-Classic/O.W. Eco-Classic	3-1/8" Thick	3.68	76.3	—	—	2,719	—
Geolink	4"h x 12"w x 16"l	1.12	32	36	36.6	1,469	—
Monoslab® Grass Paver	4-1/2"h x 16"w x 24"l	0.38	95.76	36	31.65	3,031	—

	Description	Units Per Sq. Ft.	Sq. Ft. Per Cube	Units Per Cube	Weight Per Sq. Ft.	Weight Per Cube	Sq. Ft. Per Strap
SPECIAL ORDER PAVERS (Continued)							
Symetry®	3-1/8" Thick	3.4	65	224	37	2,405	18
6" x 6" (Use In Combination With Symetry)	3-1/8" Thick	4.1	71.4	294	37	2,642	18
Durastone	2-3/8" Thick	3.6	100	360	28	2,800	20
	3-1/8" Thick	3.6	78	280	37	2,886	—
Omnistone	2-3/8" Thick	3.5	103	360	28	2,884	20.6
Honeycomb	2-3/8" Thick	3.1	87	270	28	2,436	14.5
Plazastone	2-3/8" Thick	2.73	89	243	28	2,492	17.8
Vintage Extra Large Rectangle Cube	9-1/2" x 4-3/4" x 2-3/8"	3.1	90	280	28	2,509	17.92
Vintage Double Large Rectangle Cube	7-1/8" x 9-1/2" x 2-3/8"	2.2	91	200	28	2,548	—
Vintage Large Square Cube	9-1/2" x 9-1/2" x 2-3/8"	1.6	97	160	28	2,716	—

INVENTORIED WALL STONES	Size	Exposed Face Area	Weight (lbs.)	Units Per Cube	Weight Per Cube (lbs.)	Linear Foot Coverage	
Garden Wall	4"h x 12"w x 8"d	1/3 Sq. Ft. (4" x 12")	25	96	2,352	1 l.f.	
Glenstone/O.W. Glenstone	4"h x 12"w x 8"d	1/3 Sq. Ft. (4" x 12")	32	96	3,072	—	
Old World 4" Radius Glenstone	4"h x 12-1/4"/9-1/8"w x 8"d	1/3 Sq. Ft. (4" x 12")	28	96	2,645	—	
Glenstone/O.W. Glenstone Bullnose	4"h x 8"w x 12"d	0.22 Sq. Ft. (4" x 8")	29.7	96	2,858	0.67 l.f.	
Murino							
6" Large Unit	6"h x 10"d x 16"/14"w	1 Set = 0.83 Sq. Ft. Max.	80 per set	30 Sets/Cube	2,478	1 Set = 1.8 l.f. Max.	
6" Small Unit	6"h x 10"d x 6"/4"w						
Stonegate/O.W. Stonegate							
6" Large Unit	6"h x 10"d x 16"/14"w	1 Set = 1.4 Sq. Ft. Max.	66	20 Sets/Cube	2,928	1 Set = 2.5 l.f. Max.	
6" Medium Unit	6"h x 10"d x 12"/10"w		47				
6" Small Unit	6"h x 10"d x 6"/4"w		23				
Verazzo Stone	6"h x 10-1/2"d x 16"/12"w	1 Unit = 0.58 Sq. Ft. Avg.	73	45	3,272	1 Unit = 1.16 l.f. Avg.	
Verazzo Return Corner	6"h x 8"d x 16"w	0.67 Sq. Ft.	62.8	48	3,015	1.33 l.f.	
Fire Pit Block/O.W. Fire Pit Block	5-1/2"h x 6"d x 15-1/2"/12-1/2"w	—	39	75	2,910	—	
Sculptured Split Face Units							
Compac	8"h x 18"w x 11"d	1 Sq. Ft. (8" x 18")	78	36	2,808	1.5 l.f.	
Straight Split Face Units							
Compac	8"h x 18"w x 11"d	1 Sq. Ft. (8" x 18")	79	36	2,844	1.5 l.f.	
Hewnstone Compac	8"h x 18"w x 11"d	1 Sq. Ft. (8" x 18")	86	36	3,096	1.5 l.f.	
Hewnstone Return Corner	8"h x 6"d x 15"w	0.83 Sq. Ft.	53.4	48	2,563	1.25 l.f.	
Universal Cap Unit	3-1/2"h x 18"w x 12"d	0.44 Sq. Ft. (3-1/2" x 18")	62	56	3,472	1.5 l.f.	
Universal Stair Tread	3-1/2"h x 18"w x 20"d	0.44 Sq. Ft. (3-1/2" x 18")	106	28	2,968	1.5 l.f.	
90 Degree Return Corner Units							
8" 90° Return Corner	8"h x 18"w x 9"d	1 Sq. Ft. (8" x 18")	86	30	2,580	—	
3" Caps/Coping							
3" x 24" Cap	3"h x 12"d x 24"w	1/2 Sq. Ft. (3" x 24")	72	48	3,504	2 l.f.	
Country Corner	3"h x 12"d x 12"w	1/4 Sq. Ft. (3" x 12")	36	96	3,504	1 l.f.	
Coping Stone	3-7/8"w x 12 7/8" Length x 2-3/8" Thick	2.83 Pcs/Sq. Ft.	10	117	1,170	0.33 l.f.	
SPECIAL ORDER WALL STONES							
Mini Straight Split	4"h x 18"w x 11"d	1/2 Sq. Ft. (4" x 18")	43	63	2,709	1.5 l.f.	
Mini Sculptured Split	4"h x 18"w x 11"d	1/2 Sq. Ft. (4" x 18")	46	56	2,576	1.5 l.f.	
Mini Cap Sculptured Split	4"h x 18"w x 11"d	1/2 Sq. Ft. (4" x 18")	46	56	2,576	1.5 l.f.	
4" 90° Return Corner	4"h x 18"w x 9"d	1/2 Sq. Ft. (4" x 18")	43	60	2,580	—	
Compac Cap Sculptured Split	8"h x 18"w x 11"d	1 Sq. Ft. (8" x 18")	96	32	3,072	1.5 l.f.	
Country Manor SE - Smooth Ends							
6" Large Unit	6"h x 10"d x 16"/14"w	1 Set = 1.4 Sq. Ft. Max.	66	20 Sets/Cube	2,928	1 Set = 2.5 l.f. Max.	
6" Medium Unit	6"h x 10"d x 12"/10"w		47				
6" Small Unit	6"h x 10"d x 6"/4"w		23				
3" Large Unit	3"h x 10"d x 16"/14"w	1 Set = 0.7 Sq. Ft. Max.	35	40 Sets/Cube	3,088	1 Set = 2.5 l.f. Max.	
3" Medium Unit	3"h x 10"d x 12"/10"w		26				
3" Small Unit	3"h x 10"d x 6"/4"w		12				
Country Manor Return Corner							
6" Large Unit	6"h x 10"d x 16"/14"w	1 Set = 1.4 Sq. Ft. Max.	70	20 Sets/Cube	2,928	1 Set = 2.5 l.f. Max.	
6" Medium Unit	6"h x 10"d x 12"/10"w		50				
6" Small Unit	6"h x 10"d x 6"/4"w		25				
3" Country Manor Return Corner Large	3"h x 10"d x 16"/14"w	1 Set = 0.7 Sq. Ft. Max.	36	40 Sets/Cube	3,088	1 Set = 2.5 l.f. Max.	
3" Country Manor Return Corner Medium	3"h x 10"d x 12"/10"w		27				
3" Country Manor Return Corner Small	3"h x 10"d x 6"/4"w		13				
Sculptured Split Face Units							
Standard	8"h x 18"w x 22"d	1 Sq. Ft. (8" x 18")	116	20	2,320	1.5 l.f.	
Straight Split Face Units							
Standard	8"h x 18"w x 22"d	1 Sq. Ft. (8" x 18")	128	20	2,560	1.5 l.f.	

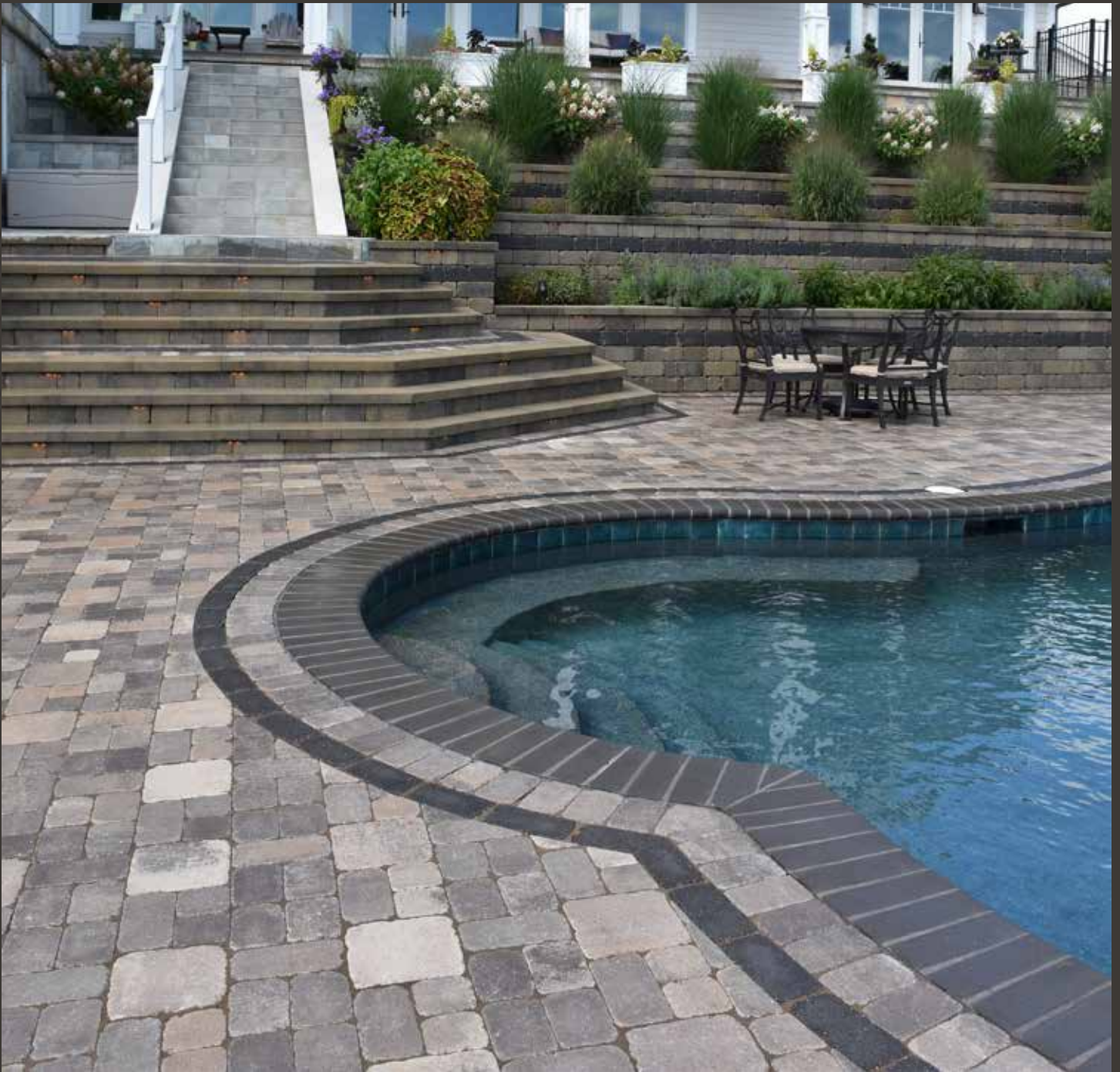

FENDT 1924
96
YEARS
MADE IN MICHIGAN
PAVERS - WALL STONES

22005 Gill Rd. / Farmington Hills, MI 48335-4646
(248) 474-3211

3285 W. Liberty / Ann Arbor, MI 48103-9795
(734) 663-4277

www.fendtproducts.com